

Sustainable Design and Construction Supplementary Planning Document (2026)



Nuneaton
&
Bedworth
United to Achieve



Sustainable Design and Construction Supplementary Planning Document

2026

Author and Version information

Name	Planning Policy	Approved by	Full Council
Version no	4		
Date of adoption	30 th April 2026		

Contents

List of Figures	5
List of Tables	7
1. Executive Summary	8
2. Purpose of the Supplementary Planning Document	10
3. Policy Context	12
National Planning Policy Framework	12
Borough Plan	13
4. Feasibility Studies and Associated Supporting Information	14
5. Sustainable Design and Construction Checklist	15
Part A: Residential Development	21
6. Local Context	22
7. Current Use of Buildings	24
8. Ownership/Tenure	25
9. Street Layout	26
Pedestrian-Scaled Environments.....	27
Visual Interest	30
10. Pattern of Development	37
Density.....	39
11. Residential Amenity	40
Defining Residential Amenity	40
Daylight, Sunlight and Privacy	40
Outdoor Amenity Space – Gardens / Open Space	43
Outdoor Amenity Space - Transport	46
Waste	47
Conversion of Non-Residential Buildings for Residential	51
Sub-Division of Dwellings to Self-Contained Units.....	51
Change of Use from a Dwelling House to a House in Multiple Occupation	52
12. Size and Arrangement	53
Internal Minimum Space Standards	53
Internal Layout.....	54
13. Built Form	55
Nuneaton and Bedworth's Residential Character	56
Extensions and Alterations to Existing Houses.....	60

Industrial, Storage and Distribution Development.....	64
Part B: Major Residential Development	65
14. Building for a Healthy Life	66
15. Greywater Recycling	67
16. Passive Solar Design	68
Passive Solar Design - Building Orientation	68
Passive Solar Design - Room Layout	70
Passive Solar Design – Glazing.....	70
Passive Solar Design - Thermal Mass.....	70
Passive Solar Design - Passive Ventilation	75
Passive Solar Design – Statement	77
17. Secured By Design.....	78
Through Roads and Cul-de-Sacs	78
Footpath and Bicycle Route Design.....	79
Communal Areas and Play Spaces	80
Layout and Orientation of Dwellings	80
Gable End Walls.....	80
Vehicle Parking.....	81
18. Air, Soil, Noise and Light Pollution.....	83
Air Pollution	83
Noise Quality	83
Noise Criteria.....	86
Noise and Vibration Assessments	87
Light Pollution	87
Soil.....	89
Part C: Major Commercial Development.....	90
19. BREEAM.....	91
How BREEAM Works	91
Required Standard for New Developments	93
Pre-Assessment	94
Part D: Sustainable Construction	95
20. Sustainable Materials and Management.....	96
Construction.....	96
Demolition Method Statement and Construction Management Plan.....	97
Construction Waste	98

List of Figures

Figure 1: Camp Hill development in Nuneaton provided an easily understood layout, creating a feature out of the existing St Mary and St John Parish Church	22
Figure 2: Street height to width ratio	28
Figure 3: Example of poor and good street design	29
Figure 4: Permeable cycle and pedestrian routes with connectivity to adjoining places	30
Figure 5: Redevelopment of Camp Hill, Nuneaton demonstrates traditional red brick designs with occasional pastel-coloured buildings, with varying designs providing visual interest.	31
Figure 6: Camp Hill, Nuneaton	32
Figure 7: Camp Hill development in Nuneaton provided a distinctive building on an important road junction to aid navigation	33
Figure 8: Example of poor and good designs on street bend	34
Figure 9: Position of utilitarian buildings	35
Figure 10: North Nuneaton, flat over parking	35
Figure 11: Parking dominated street scene should be avoided	36
Figure 12: Make use of existing links to determine pattern of development	38
Figure 13: Different patterns of development	38
Figure 14: Protecting privacy and preventing an oppressive sense of enclosure.	41
Figure 15: Habitable room windows overlooking neighbouring private amenity space	42
Figure 16: Protecting light and preventing an oppressive sense of enclosure	42
Figure 17: Building lines of adjacent dwellings	43
Figure 18: An inappropriate garden shape	44
Figure 19: Inappropriate narrow strip of open space between the rear of housing	45
Figure 20: Direction of the sun, a northerly aspect may require a longer garden	46
Figure 21: Bin storage for various buildings	50
Figure 22: Development stages in Nuneaton and Bedworth Borough	55
Figure 23: Map of Nuneaton and Bedworth landscape character areas	59
Figure 24: Extensions which are in keeping with the design and scale of the existing house and the group within which it is sited	60

Figure 25: Extensions which are in keeping with the design and scale of the existing house and the group within which it is sited	60
Figure 26: Extensions which are in keeping with the design and scale of the existing house and the group in which it is sited	61
Figure 27: An intrusion in the street scene	61
Figure 28: Extension designed with a double frontage effect	62
Figure 29: Extensions unsympathetic to the original roof form of the house	62
Figure 30: Good dormer design on left. Unsatisfactory dormer designs not fitting into roof form on right	63
Figure 31: Existing character spoiled by unsympathetic windows in extension on left; character retained by using windows in keeping with original on right	63
Figure 32: Passive solar design building orientation	68
Figure 33: Building size location in relation to sun	69
Figure 34: Tree function in Passive Solar Design	70
Figure 35: Thermal mass: absorbing and releasing heat	71
Figure 36: Thermal mass and ventilation	76
Figure 37: The waste hierarchy	99

List of Tables

Table 1: Height to width ratios	27
Table 2: Minimum gross internal floor areas and storage (m²)	53
Table 3: Predominant generic character types	56
Table 4: Nuneaton and Bedworth landscape character areas	59
Table 6: Thermal mass components	71
Table 7: Admittance values for building constructions	72
Table 8: Noise levels	84
Table 9: Effects of noise	86
Table 10: BREEAM benchmarks	92
Table 11: Increase in capital cost to achieve BREEAM benchmarks	93

1. Executive Summary

- 1.1 This Supplementary Planning Document (SPD) provides guidance on how to meet the requirements of Nuneaton and Bedworth Borough Plan's Policy BE3: Sustainable Design and Construction. The SPD does not create new policy but explains how sustainable design and construction will be addressed in the borough.
- 1.2 Good design is the cornerstone of Planning and there are numerous publications covering the subject. There are seven established principles for successful urban design:
- 1.3 **Character** - Good designs should respond to and reinforce locally distinctive patterns of development and landscape character.
- 1.4 **Continuity and Enclosure** – Developments should clearly define public and private space by creating clear frontages to streets and open spaces.
- 1.5 **Quality of the Public Realm** – Developments should create spaces that enhance the feeling of safety and which are visually attractive. Spaces should be accessible to all groups of society and offer opportunities for people to meet and socialise.
- 1.6 **Ease of Movement** – Developments should connect to each other, be easy to move through, put people before traffic and integrate with transport networks. Places that are open to pedestrians will help reduce congestion and air pollution.
- 1.7 **Legibility** – Developments should be easy to navigate using landmarks to help people find their way.
- 1.8 **Adaptability** – Developments should consider future adaptability to changing social, economic, and technological conditions. Developments should consider how buildings and spaces will remain relevant to users over a long period of time. The challenge of climate change means places need to be adaptable to changes in climate patterns.
- 1.9 **Diversity** – Development should provide choice and diversity through a mix of compatible developments and activities. A place should be designed to be used by as many people as possible regardless of background or physical ability.

- 1.10 The importance of sustainability within the design process is increasingly recognised. The need to balance economic, environmental, and social issues has long been established. In the UK, the influential Stern Review¹ was published in 2006, and moved sustainability from the periphery to a central concern of government and business. Sustainability has continued to influence government policies, and is intrinsic to the National Planning Policy Framework.
- 1.11 Sustainability will inevitably be shaped by global, national and local political concerns. Nuneaton and Bedworth Borough Council will remain committed to the principles of sustainable design and construction, and will continue to make use of developing knowledge in sustainability for the benefit of current and future residents, visitors and workers.

¹ Stern, N. (2006) *The Economics of Climate Change: The Stern Review*

2. Purpose of the Supplementary Planning Document

- 2.1 Every development site is different, and presents unique challenges and opportunities. The Council will respond positively to applications which incorporate the design principles outlined in Policy BE3: Sustainable Design and Construction and expanded upon in this SPD.
- 2.2 The SPD comprises four parts as follows.
- **Part A: All Residential Development** - Relevant to all residential development proposals, and considers design within the local context.
 - **Part B: Major Residential Development** - Applicable to all major residential development proposals, and provides details of what should be addressed in the planning statements required by the Borough Plan.
 - **Part C: Major Commercial Development** - Applies to major non-domestic development, and provides an explanation of the BREEAM requirement requested in the Borough Plan.
 - **Part D: Sustainable Construction** – Relevant to all development, and provides details on the requirements for the construction phase of development.
- 2.3 The term 'major development' follows the definition found in the National Planning Policy Framework, Annex 2 "For housing, development where 10 or more homes will be provided, or the site has an area of 0.5 hectares or more. For non-residential development it means additional floorspace of 1,000 m² or more, or a site of 1 hectare or more, or as otherwise provided in the Town and Country Planning (Development Management Procedure) (England) Order 2015".
- 2.4 A Sustainable Design and Construction checklist is included in Section 5. Developers are expected to provide a completed checklist showing how the requirements of "Policy BE3 - Sustainable Design and Construction" and the contents of this SPD have been taken into account in their proposal. Completion of the checklist will

ensure applications are compliant with the Borough Plan policy and can be dealt with efficiently.

3. Policy Context

National Planning Policy Framework

- 3.1 The National Planning Policy Framework (NPPF) provided the national framework within which the Borough Plan has been prepared.
- 3.2 The NPPF (2024)² in section 12 sets out the government policy towards well designed places. Paragraph 135 lays out the principles which developments should adhere to as follows.

“Planning policies and decisions should ensure that developments:

- will function well and add to the overall quality of the area, not just for the short term but over the lifetime of the development;
- are visually attractive as a result of good architecture, layout and appropriate and effective landscaping;
- are sympathetic to local character and history, including the surrounding built environment and landscape setting, while not preventing or discouraging appropriate innovation or change (such as increased densities);
- establish or maintain a strong sense of place, using the arrangement of streets, spaces, building types and materials to create attractive, welcoming and distinctive places to live, work and visit;
- optimise the potential of the site to accommodate and sustain an appropriate amount and mix of development (including green and other public space) and support local facilities and transport networks; and
- create places that are safe, inclusive and accessible and which promote health and well-being, with a high standard of amenity for existing and future users; and where crime and disorder, and the fear of crime, do not undermine the quality of life or community cohesion and resilience”.

- 3.3 The NPPF recognises the importance of involving local communities in the design process, stating in paragraph 137 the following.

² Ministry of Housing, Communities & Local Government (2024) *National Planning Policy Framework*

- “Applications that can demonstrate early, proactive and effective engagement with the community should be looked on more favourably than those that cannot”.

Borough Plan

- 3.4 The Borough Plan “Policy BE3 - Sustainable Design and Construction” sets out the local interpretation of the NPPF. The policy should be read in context with the Borough Plan as a whole and related SPDs, as well as any further updates to the NPPF or associated guidance.

4. Feasibility Studies and Associated Supporting Information

- 4.1 Developers who are unable to meet the requirements of the policy are required to show full justification as to why the policy cannot be met. The justification should be completed to allow the council to understand the developer's decision-making process; including all of the potential options the developer has considered, and why non-conformance with the policy could jeopardise the project.
- 4.2 Where a major development does not meet the residential requirements of the policy, an independent viability assessment must be submitted with the application.

5. Sustainable Design and Construction Checklist

5.1 All planning applications should complete a Sustainable Design and Construction Checklist, confirming where in the application the policy requirement has been addressed. Where the information will be provided at a subsequent stage in the application process, it is acceptable to note this within the relevant column. The checklist is available below:

Priority	Key consideration	Applicable to development type	Where referenced/ considered/ justified in developer's planning application	Yes or No
Local Context	Has local context been addressed in the application?	All applications		
Current Use of Buildings	Is the development in sympathy with the uses and activities of the surrounding area?	All applications		
Ownership and Tenure	Is the proposed ownership/tenure supported by evidence?	Major residential applications		
Street Layout	Has the user hierarchy been followed in the design process?	Major applications		
Street Layout	Do the designs support sustainable transport options?	Major applications		

Street Layout	Has the visual interest of the street layout been considered in the application?	All residential applications		
Patterns of Development	Does the building arrangement consider the existing streetscape?	All applications		
Residential Amenity- Daylight	Have daylight, sunlight and privacy been considered in the application?	All applications		
Residential Amenity - Outdoor	Has outdoor amenity space been considered in the application?	All residential applications		
Residential Amenity - Transport	Has the storage of transport vehicles been considered in the application?	All residential applications		
Residential Amenity- Waste	Is there sufficient space for bin storage which protects visual amenity and prevents risk of hazards?	All residential applications		
Size and Arrangement - Internal Minimum Space Standards	Does the design conform to the Technical Housing Standards- Nationally Described Space Standard?	All residential applications		

Built Form	Does the design have regard for characteristics of the area?	All residential applications		
Built Form	Where developments occur within a Landscape Character Area, have the guidelines in the latest Nuneaton and Bedworth Landscape Character Assessment guidelines, or the Nuneaton and Bedworth Land Use Designations, been adhered to?	All residential applications		
Built Form - Extensions and Alterations to Existing Houses	Are the proposed alterations in conformity with the recommendations in this SPD?	All household applications		
Residential - Building for a Healthy Life	Does the development achieve green lights against all 12 considerations in Building for a Healthy Life?	Major residential applications		
Passive Solar Design	Is the overall design in accordance with the principles of Passive Solar Design?	Major residential applications		

Secured By Design	Does the application incorporate the principles of Secured By Design (SBD) contained within the relevant SBD design guide?	Major residential applications		
Air Pollution	In non-strategic allocations, does the application include an air quality assessment?	Major residential applications		
Air Pollution	In areas with sensitive receptors, does the application include an air quality assessment?	Major residential applications		
Noise Quality	Where requested by the Council, does the application include a Noise Impact Assessment?	Major residential applications		
Light Pollution	Is the lighting at a level for which it is intended, and does not cause disruption to other street users	Major residential applications		
Light Pollution	Does the lighting infrastructure enhance the overall look of the street design?	Major residential applications		

Soil	Does the Site Waste Management Plan identify soils and detail their protection during construction and subsequent re-use?	Major residential applications		
Commercial: BREEAM	Has a BREEAM design stage assessment, which achieves at least a very good rating, been submitted prior to development?	All major commercial applications		
Commercial: BREEAM	Has a commitment been made to submit post construction certificates which achieve a minimum very good rating?	All major commercial applications		
Sustainable Construction	If required, has a Demolition Method Statement been completed?	All major applications		
Sustainable Construction	Has a Construction Management Plan been completed?	All major applications		
Construction Waste	If demolition cannot be avoided, has an audit been included in the Site Waste	All major applications		

	Management Plan which shows the percentage of materials which can be reused or recycled?			
Construction Waste	Does the site waste management plan have a significant impact on the recovery rate?	All major applications		

Part A: Residential Development

6. Local Context

- 6.1 Developments should take into account the local context, and consider the layout of existing buildings, streets and landscape. The application should include a statement which addresses the context and how this has influenced the design.



Figure 1: Camp Hill development in Nuneaton provided an easily understood layout, creating a feature out of the existing St Mary and St John Parish Church

- 6.2 The statement should identify key locations and services which may be impacted by the development, or which may impact on what is proposed.
- 6.3 The contents of the statement will depend upon the size and scale of the proposal. In major developments the local context should be addressed in the design and access statement.
- 6.4 Possible areas to address in the context appraisal include the following.
- **Existing characteristics** - Existing routes through the site, landscape features, existing buildings, wildlife sites and boundary treatments.

- **Position of the development site** - Architectural form of surrounding buildings, and the location of the site in relation to the wider area.
- **Movement** - Surrounding road hierarchy, location and frequency of public transport, location of local services and facilities, adjacent land uses and local landmarks.
- **Building layouts** - Road layouts, building arrangement, and building and street ratio.
- **Streetscape** - Building materials, prevailing building design and distinctive building design.
- **Natural landscape** - Topography, views of/from the site, location of nearby open spaces, footpaths, green spaces, wildlife habitats and areas of geodiversity interest.
- **Building design** – Prevailing form, building materials, roof design, scale, and door and window design.

7. Current Use of Buildings

- 7.1 Development proposals should show an understanding of the local impact of the new development on the immediate and surrounding properties.
- 7.2 Existing users should not be expected to have to adapt their activities as a result of new development, such as the change of operational hours for commercial uses.
- 7.3 Developments should not create buildings which visually overwhelm the character of the area in ways which impact negatively on the current use of buildings in the area.

8. Ownership/Tenure

- 8.1 In accordance with Borough Plan “Policy H1 - Range and mix of housing”, justification for the proposed tenure mix should be provided based on the latest available Housing and Economic Development Needs Assessment, as well as the characteristics of the surrounding area.
- 8.2 Major housing developments should have a mix of housing units that will allow people to change the size of their accommodation as required in order to continue to live within the development.
- 8.3 In accordance with “Policy H2 – Affordable housing”, a proportion of the required affordable housing on major developments should provide units for the rental sector. The exact tenure, size and mix should be identified through discussions with the local authority and informed by the council’s latest published housing need evidence.

9. Street Layout

- 9.1 Warwickshire County Council are responsible for highways, as well as road and estate adoptions in the borough. Warwickshire Council Council's Highway Design Guide (HDG) is the primary design standard for all adoptable highway and public realm works. It should be noted that this SPD does not supersede the highway authority's technical requirements.
- 9.2 The guidance within this SPD refers to streets which perform an important function in the public realm, typically lined with buildings and public spaces. Trunk roads and strategic routes which are primarily concerned with traffic movement will be addressed by national guidance.
- 9.3 Good street design is a collaborative process, and it is important to involve all potential stakeholders early in the design process.
- 9.4 Early engagement with agencies will help to identify conflicting priorities, prevent the domination of certain street users over others and prevent late changes in the design, which have less time to be worked through. Potential early consultees include:
- Disability and other user groups
 - Emergency services
 - Highway authorities
 - Planning authorities
 - Public transport providers
 - Utility companies
 - Waste collection service
- 9.5 There are complex pieces of legislation, policies and guidance relating to the design of highways. While legal requirements should be adhered to, designers should not be constrained by established norms.
- 9.6 If the context of a site is more suitable for innovative designs which promote sustainable forms of transport, community interaction or road safety, these are to be encouraged. Equally, design that serves no purpose to street functionality should be avoided.

Pedestrian-Scaled Environments

- 9.7 Designs should consider the needs of pedestrians. Spaces should be of visual interest and of a height and scale which is not intimidating to the pedestrian. The requirements of users with limited vision and/or mobility should be addressed in the application.
- 9.8 The design process should follow the user hierarchy of; first pedestrians, then cyclists, public transport users, specialist service vehicles (e.g. emergency services, waste, etc.) and lastly other motor traffic.
- 9.9 The height of buildings in relation to the width of the space can impact upon the visual experience of the street. The Manual for Streets³ recommends height to width ratios which should be followed in the borough as follows.

Table 1: Height to width ratios⁴

	Maximum	Minimum
Minor Streets, e.g. Mews	1:1.5	1:1
Typical Streets	1:3	1:1.5
Squares	1:6	1:4

- 9.10 Where building heights do not provide a sense of enclosure, such as on a wide road, street trees can provide a similar sense of definition and enclosure.

³ Department for Transport (2007) *Manual for Streets*

⁴ Department for Transport (2007) *Manual for Streets*

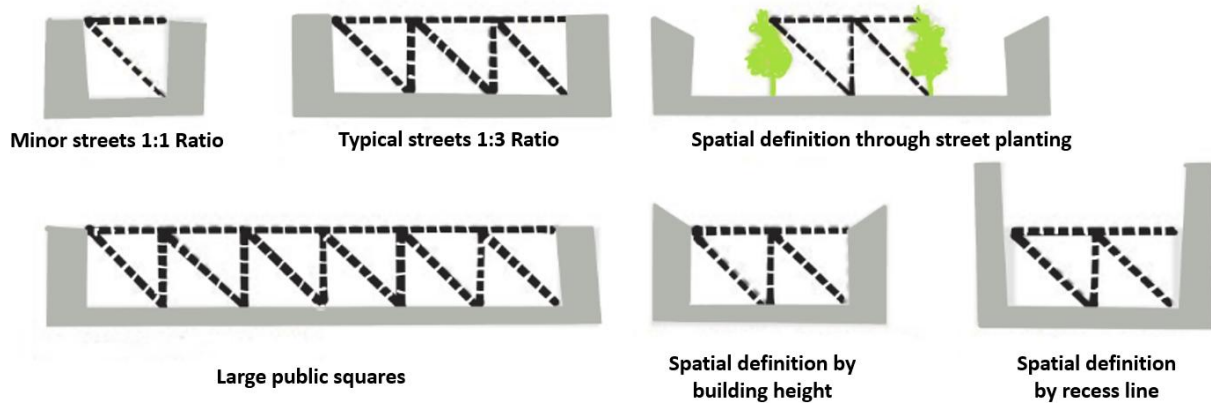

Figure 2: Street height to width ratio⁵

9.11 Long straight roads can promote the needs of pedestrians and cyclists who prefer direct routes and therefore enhance connectivity. However, longer roads can encourage higher traffic speeds, be daunting for pedestrians and lack sufficient variety to maintain visual interest. Techniques to break down the length of the street should be used. Long spaces can be treated as sub-spaces with variations within them. Techniques include changes to the building line, angling facades, or changes in minor details to buildings. Streets can be angled or the horizontal alignment changed to maintain anticipation and create interest for the pedestrian.

⁵ Department for Transport (2007) *Manual for Streets*



Incorrect: A long and unchanging street is visually uninteresting and can be daunting for the pedestrian.

Correct: Curved street design limits the visual length, creates a sense of anticipation and makes longer walks appear more manageable.

Figure 3: Example of poor and good street design

- 9.12 Residential streets should be designed to keep traffic to low speeds. However, unnecessary road clutter such as speed humps should be avoided. Changes in horizontal alignment provides for a more consistent traffic speed and therefore a safer pedestrian environment.
- 9.13 To encourage non-motorised modes of transport for short journeys, streets should be permeable and have connectivity to other streets, facilities and public transport systems. Preferential routes for bikes and pedestrians should be adopted where possible (see figure 4).

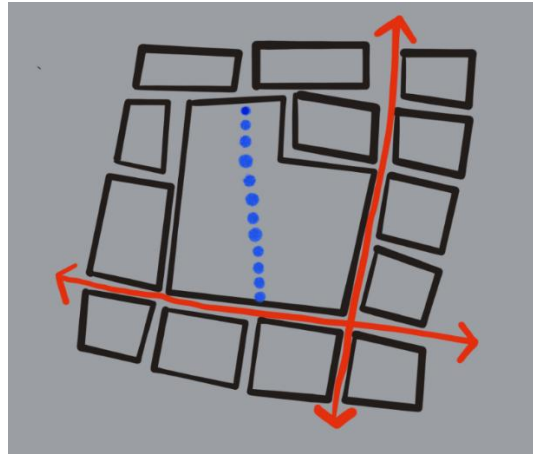

Figure 4: Permeable cycle and pedestrian routes with connectivity to adjoining places

- 9.14 Ease of navigation should be considered alongside physical permeability as part of the overall street design.
- 9.15 Physical barriers to protect pedestrians from traffic can be visually unattractive and a hazard to cyclists. They also reinforce the impression that roads are solely for motor traffic, therefore they should only be used where there is an overriding safety concern.
- 9.16 Provision for cyclists should be considered in relation to the volume and speed of traffic.
- 9.17 To encourage walking and cycling, and to assist those with mobility problems, settlements should have sufficient areas to rest, including shelters, sited at regular intervals. Also in relation to assisting those with mobility problems, dropped kerbs need to be provided at all road junctions on both sides of each road. Dropped kerbs will also be needed to connect open space paths which cross roads. In all cases, dropped kerbs provided for those with mobility problems need to align with a dropped kerb on the opposite side of the road, and cover the shortest possible distance.

Visual Interest

- 9.18 A visual cacophony of designs producing a bewildering street experience should be avoided, as this is not an appropriate solution to creating visual interest. In general, the materials appropriate to Nuneaton and Bedworth are local red or orange brick and plain clay tile or slate, however the punctuation of colour can add to the visual

scene. Figure 5 demonstrates how these principles have been achieved in Camp Hill, Nuneaton.



Figure 5: Redevelopment of Camp Hill, Nuneaton demonstrates traditional red brick designs with occasional pastel-coloured buildings, with varying designs providing visual interest.

9.19 The context appraisal should inform the end design. Figure 6 demonstrates how the redevelopment of Camp Hill, Nuneaton has worked with the land gradient to provide views which provide a depth of vision.



Figure 6: Camp Hill, Nuneaton

- 9.20 Development should be sympathetic to the edge conditions of the settlement area. The borough is predominantly surrounded by Green Belt and countryside. Edge conditions should respond using recessive colours for roofs and brickwork to help reduce the prominence of the urban edge.
- 9.21 Developments should consider the rhythm of the existing buildings. Where heights of chimneys, windows, eaves, etc., conform to a uniform pattern, deviations to uniformity will not be considered appropriate.
- 9.22 Developments which infill or are a continuation of an existing street should follow the existing development line defined by the immediately adjoining property. Where proposals deviate from the existing line of development, applicants should demonstrate how the design enhances the overall street scene.
- 9.23 Windows on an elevation should be consistent in terms of size, shape and materials. To maintain balance they should usually have the same lintel and/or sill height as others on the same floor and line up vertically with those on floors above or below. Windows

above ground floor should not be taller than those below. The use of shorter windows on upper floors can enhance the sense of vertical perspective to good effect. Similarly, dormer windows should be smaller in height and width than the window opening below and, as far as possible, align vertically with them.

- 9.24 To aid in navigation of places, the positioning of buildings should be given careful consideration. Ease of navigation can be helped by the positioning of distinctive buildings and street furniture at road junctions, curves in the road, cul-de-sac ends or connections to existing public rights of way. Buildings in these areas should have a strong visual element such as a landmark house, site-specific design or well-designed community facility.



Figure 7: Camp Hill development in Nuneaton provided a distinctive building on an important road junction to aid navigation

- 9.25 Public spaces should be faced by the front of buildings and not by the rear or sides of buildings. Where a building is located on a corner plot, the front of the building should face the road highest up the street hierarchy, i.e. a corner building facing both a main and secondary street should face the main street. In addition, corner buildings should have windows on all public facing sides. Dead spaces created by long high brick walls or fences should be avoided.

These dead spaces can usually be prevented through the effective use of perimeter blocks.



Incorrect: Side of the building facing the road creates a weak visual appearance, no natural surveillance, and an unsafe community space.

Correct: The house front creates visual interest, provides space for community interaction, creates natural surveillance, and clearly indicates the continuation of the road.

Figure 8: Example of poor and good designs on street bend

- 9.26 Developments should work with the contour of the road. A series of staggered "saw-tooth" plots or a subseries running off a private drive is an unacceptable way of accommodating a bend in the road.
- 9.27 The positioning of utilitarian buildings and features should be avoided in prominent places as well as on the front elevation of domestic buildings. The general rule should be public front, private rear.



Incorrect: Front facing garages obscuring the front of the building

Correct: The front of the house is prominent; the garage is set back from the street.

Figure 9: Position of utilitarian buildings

9.28 Flat over Parking (FoP) can be used to provide parking which would not be possible to achieve in other circumstances. To provide surveillance, additional units would be required to overlook the FoP. The FoP should avoid a functional appearance, and should therefore take design cues from surrounding dwellings.



Figure 10: North Nuneaton, flat over parking

9.29 Front of plot parking can lead to a vehicle dominated street scene and should not be the only design solution for parking. Where front of plot parking is used, suitable landscaping should be deployed to enhance street enclosure.



Figure 11: Parking dominated street scene should be avoided

9.30 On development sites where electricity pylons and overhead lines are present, careful consideration should be given to how the pylons are integrated into the overall design. National Grid have provided guidelines for development near pylons and overhead lines called, "Design Guidelines for Development Near High Voltage Overhead Lines" (n.d.). The guidelines assist local authorities, developers and local communities to plan for development around National Grid infrastructure. The guidelines set out eight design principles to help promote environment quality and diminish the impact of overhead lines. On sites with overhead lines, applications should follow the principles set out in the National Grid guidelines.

10. Pattern of Development

- 10.1 The pattern of development is an important consideration in the design process. Patterns influence how residents will travel, how much time they may commute, if they decide to walk or cycle, how healthy communities are, how they affect the climate and how much pollution they generate.
- 10.2 Traditional forms of development tend to use a grid format, however over time technology has produced a variety of patterns ranging from traditional grid formations to loops and circles.
- 10.3 The context appraisal will help to identify the existing pattern of development and how one place relates to another place. The context appraisal can then inform how buildings and streets are to be arranged. The application should demonstrate how the proposed pattern of development works within the surrounding context.
- 10.4 Cul-de-sacs are not considered sustainable due to the requirement for turning heads which is wasteful of land and can lead to unnecessary vehicle emissions. Street networks should generally be permeable to allow for ease of movement, whilst also encouraging walking and cycling⁶. Cul-de-sacs may be required due to topographical constraints, however it should be demonstrated that alternative design solutions are not viable before a cul-de-sac layout is considered acceptable.
- 10.5 Existing road links to the development site should form the basis of development. Where there are several links which could connect the site, those with the most connections should be prioritised (Bentley et al, 1986)⁷.

⁶ Department for Transport (2007) *Manual for Streets*

⁷ Bentley, I., Alcock, A., Murrain, P., McGlynn, S., and Smith, G. (1985). *Responsive Environments*

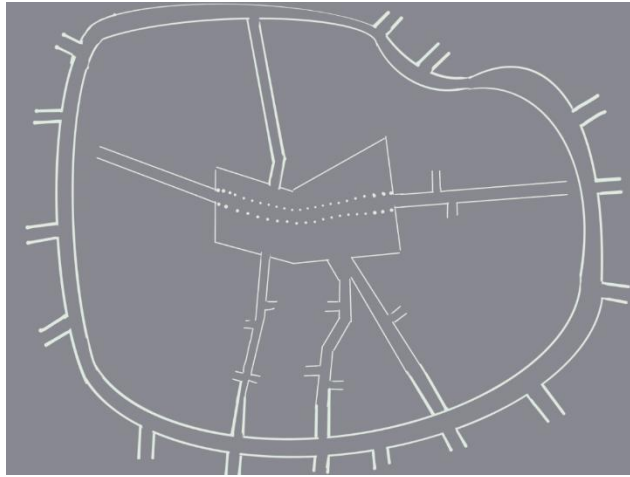

Figure 12: Make use of existing links to determine pattern of development

10.6 Where there are no links to connect the development site, the pattern of development should consider the end use of the area; for example concentric grids can lead to a local centre or transport hub. Irregular layouts can provide an interesting, meandering experience whilst conventional rectilinear grids will provide efficient movement of vehicles⁸.

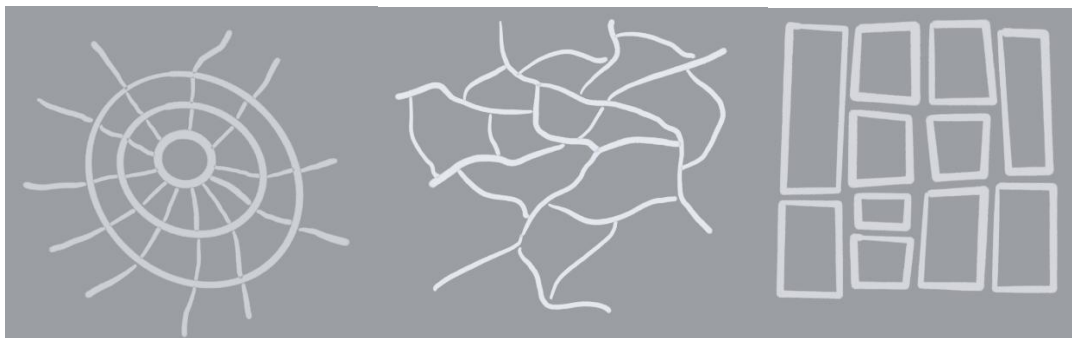

Figure 13: Different patterns of development

10.7 The design of developments should take into consideration the surrounding area and local pattern of development. Where there is existing development, the design should respond to the local distinctiveness of the area.

⁸ Department for Transport (2007) *Manual for Streets*

Density

- 10.8 Residential developments should be built to a density which is appropriate to the locality. Developers should demonstrate that established densities within the area have been considered in applications. In some locations it will be appropriate to build to higher densities, for example to improve the vitality of an area. In other areas, low density developments may be more appropriate to the existing street scene.
- 10.9 Determining appropriate density can be achieved through the context analysis outlined in Section 6.
- 10.10 Where higher density developments are proposed, the following principles should be used.
- Town centres or public transport corridors where there is access to good facilities and services can normally cater for higher density developments.
 - Good quality insulation between dwellings should be used for higher density developments.
 - Higher density developments should provide appropriate and usable private outside space.
 - Surrounding building heights and styles should be responded to sensitively.
 - Higher density developments should ensure that adequate parking provision is made without dominating the street scene.
- 10.11 It is important to make effective use of land within the settlement boundary. Housing can be an effective way of bringing neglected spaces back to use for the benefit of the community. New dwellings built on land which is not visible from a public highway, usually on former garden land (i.e. "backland development") should integrate successfully with surrounding developments. Designs should be appropriate to an area, and only a design of outstanding quality is acceptable where it is not in harmony with local character.

11. Residential Amenity

Defining Residential Amenity

11.1 In order to consider residential amenity, the council wish to set out what it considers this term to mean. The dictionary definition of residential is “suitable for or allocated for residence”⁹, whilst amenity is defined as “the fact or condition of being pleasant or agreeable”¹⁰. Taking these definitions into account and applying them to the planning context, the council considers residential amenity to mean dwellings which provide pleasant living conditions for their occupants.

11.2 The following sub-sections set out the council’s stance on various aspects of residential amenity.

Daylight, Sunlight and Privacy

11.3 Developers should demonstrate that daylight and sunlight impacts have been considered, having regard to surveyed heights, position of windows and ground levels.

11.4 The way buildings relate to each other – their orientation and separation distance – must provide and protect acceptable levels of amenity for both existing and future residents. The following standards of amenity can be used flexibly, depending on house layout and on-site circumstances, such as orientation; window, ceiling and roof height; levels; and garden size and shape. The standards are appropriate to both new dwellings and extensions. With regard to new dwellings, care should be taken to provide scope for later extensions and alterations that will not erode these standards.

11.5 Front, rear and side facing windows to habitable rooms should be protected from significant overlooking and overshadowing where such windows are the primary source of light and are the original openings in the house. Habitable rooms are rooms where occupants spend significant amounts of time, such as the lounge, kitchen, study, dining room and bedrooms. It does not include the

⁹ Dictionary.com (2025) *Residential*

¹⁰ Dicionary.com (2025) *Amenity*

bathroom, WC, utility rooms, hall, landing or garages. Where a room has (or originally had) two windows or more, the primary source of light will usually be the window/s (if of reasonable size) that overlook/s amenity areas.

- 11.6 In the interests of protecting privacy and preventing an oppressive sense of enclosure, a minimum 20 metres separation distance is required between the ground and first floor habitable room windows of all dwellings. Where a three-storey development is proposed a distance of 30 metres will normally be required, where such an elevation containing windows faces another elevation with windows. This is also the case where dormer windows are proposed at a three-storey level on an existing dwelling. It should also be noted that where there are significant differences in the land levels of dwellings which equate to an additional storey, a distance of 30 m should also be applied.

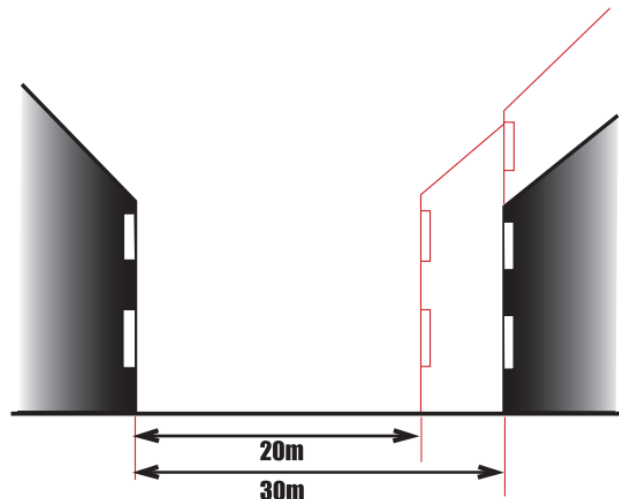

Figure 14: Protecting privacy and preventing an oppressive sense of enclosure.

- 11.7 The distances above may be reduced if they are across publicly viewed areas e.g. across a front garden, open space or public highway. It is acceptable for windows to non-habitable rooms closer than these distances to be obscure glazed and, if privacy is at particular risk, also be non-opening or with a high-level opening. The use of obscure glazing in habitable rooms to achieve lower distances is not acceptable in windows which provide the primary source of light.
- 11.8 Habitable room windows above ground floor which overlook neighbouring private amenity space shall be at least 7 metres from

the boundary. Likewise, private amenity space should be of a usable size, shape, screened from public areas and neighbouring properties.

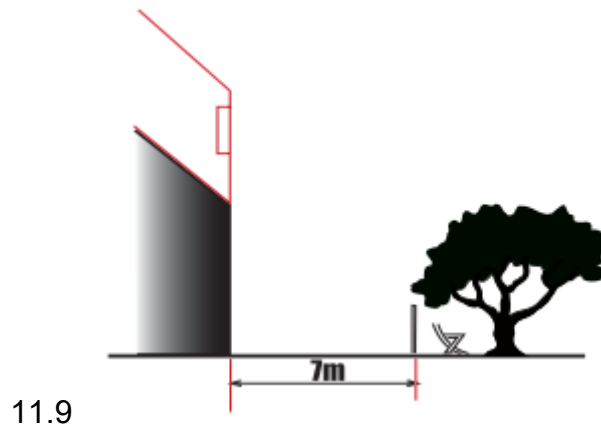

Figure 15: Habitable room windows overlooking neighbouring private amenity space

11.10 In the interests of protecting light and preventing an oppressive sense of enclosure, the blank wall of a dwelling (including an extension) directly facing the window of a habitable room of the same height shall be a minimum 12 metres apart.

11.11 The minimum distance increases to 14 metres where the dwelling (including an extension) is a storey higher and 16 metres where the difference is two storeys. These distances may be relaxed if the window is not significantly enclosed by the dwelling (including an extension).

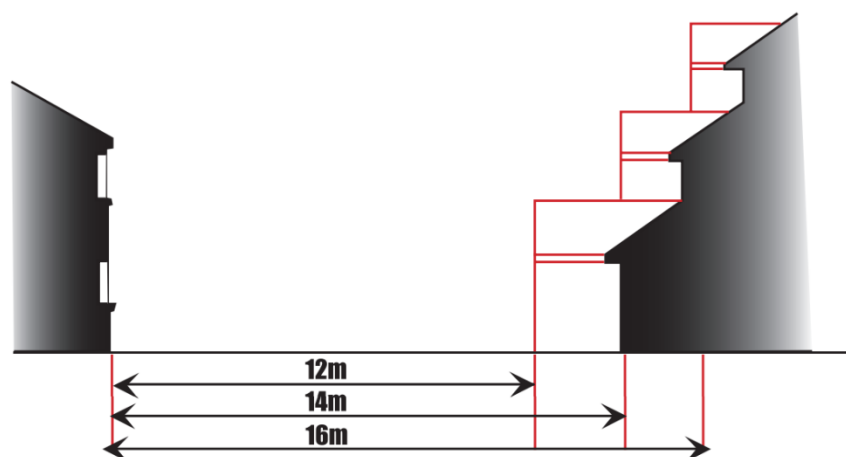

Figure 16: Protecting light and preventing an oppressive sense of enclosure

11.12A dwelling (including an extension) shall not infringe a line drawn at 60 degrees from the centre point of the window of an adjacent habitable room of the same floor level. This is usually relevant to a proposed ground floor rear extension. A proposed extension a storey higher than the window of an adjacent habitable room shall not infringe a 45-degree line. In any event, near the boundary of an adjoining usable rear private amenity space a proposed single storey extension shall be less than 4 metres long. In the same circumstances, a two-storey extension or higher shall be less than 3 metres long. Shaving off the corner of an extension or stepping-in so as to follow the required angle (either 60 or 45 degrees) is not normally acceptable because such measures do not usually significantly reduce the impact of the extension on adjoining habitable rooms or gardens.

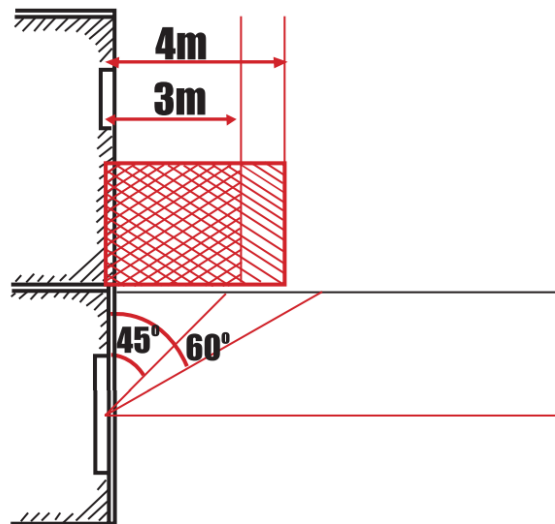

Figure 17: Building lines of adjacent dwellings

Outdoor Amenity Space – Gardens / Open Space

11.13 Gardens should be of a rectangular shape to ensure that there is space for a range of uses and to create pleasant living conditions.



Figure 18: An inappropriate garden shape

11.14 New housing development should provide sufficient amenity space to meet the recreation and domestic requirements of occupants. Sufficient private outdoor amenity space includes space for all of the following in gardens.

- Table and chairs
- Drying clothes
- Ball games / children's play
- Shed (including space for bicycles)
- Rainwater harvesting butts

11.15 Each of these uses should have their own space, and not double as another use, i.e. space for balls games should not also be counted as space for a table and chairs.

11.16 In order to ensure the above requirements are met, the recommended garden size is 100 sq m, whilst the minimum size should be 60 sq m.¹¹

11.17 In order to achieve sufficient private outdoor amenity space for apartments, proposals should deliver a minimum of 6.5 sq m of patio/balcony space for 1 bedroom and 2-bedroom dwellings, and

¹¹ Bentley, I., Alcock, A., Murrain, P., McGlynn, S. and Smith, G. (1985) *Responsive Environments*

an extra 1.5 sq m for each additional bedroom¹². As part of this, the minimum depth and width of all patios/balconies and other private external spaces is 1.5 m¹³.

11.18 Outdoor amenity space should be accessible to everyone including disabled and elderly users.

11.19 Public and private spaces should be differentiated by clear boundaries. Walls, hedges and fences should be of an appropriate scale and suitable for the houses they surround. One specific design to be avoided in relation to the interaction between public and private spaces are narrow strips of open space between the rear of two rows of housing. These narrow strips of open space have no natural surveillance due to being at the rear of dwellings, and create an environment which will likely attract criminal activity due to its isolated nature.



Figure 19: Inappropriate narrow strip of open space between the rear of housing

11.20 In general, the more northerly direction the garden is located, the longer a garden will need to be to receive good sunlight.

¹² Based on the drying space and private open space requirements of the Code for Sustainable Homes: Technical Guide (Communities and Local Government, 2010), specifically Issue IDs ENE 4 and HEA 3

¹³ Based on English Partnerships' Quality Standards: Delivering Quality Places (English Partnerships, 2007) and private open space requirements of the Code for Sustainable Homes: Technical Guide (Communities and Local Government, 2010), specifically Issue ID HEA 3

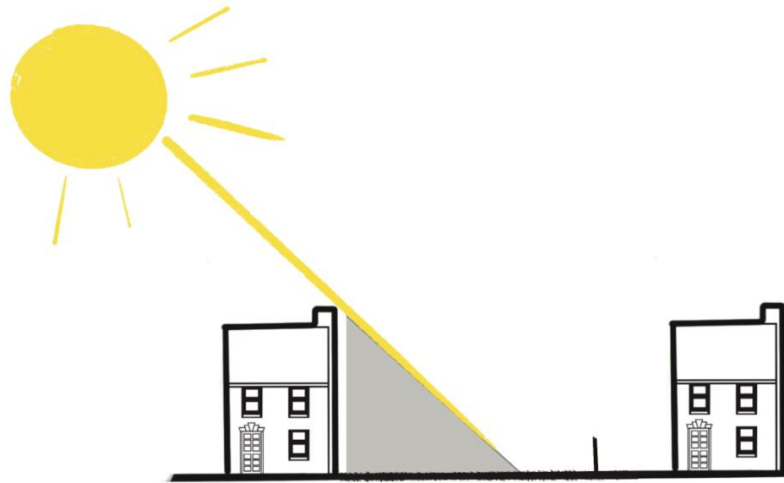

Figure 20: Direction of the sun, a northerly aspect may require a longer garden

11.21 Where there is doubt regarding sunlight, recommendations in the BRE report "Site Layout Planning for Daylight and Sunlight" (2011)¹⁴ should be followed. This states that no more than two fifths, and preferably no more than a quarter, of the garden should be prevented by obstacles from receiving sunshine on 21 March.

Outdoor Amenity Space - Transport

11.22 Car parking standards are set out in the Parking Standards SPD. The following requirements consider sustainable transport standards for domestic dwellings.

11.23 Storage areas for bicycles should be safe and secure, as well as located to allow for easy access to the transport network. Where cycle storage is intended for a rear garden, suitable gate access should be provided to ensure the bike does not need to be taken through the house. Similarly, in the case of apartments, communal cycle parking should not require bikes to be taken through any internal spaces, other than a garage. If a garage is part of a dwellings' design, there should be sufficient space to move a bike in and out of the garage past any cars parked on the driveway.

¹⁴ Littlefair, P. (2011) *Site Layout Planning for Daylight and Sunlight: A Guide to Good Practice*

- 11.24 Where cycle parking is provided for multiple bicycles in apartment blocks, the parking should be of a Sheffield stand design. Alternative designs which allow the frame of bicycles to be secured to the parking structure will also be acceptable, or bike lockers which contain the bicycle. Cycle parking which can only secure a wheel to the parking structure will not be acceptable.
- 11.25 Cycle storage needs to be incorporated in a manner which is consistent with the design and character of the proposed development, and which reflects the architecture of the wider scheme.
- 11.26 Developments with garages or parking bays should support recharging of electric vehicles. For residential developments there should be a standard charge point which is sufficient to provide a full charge overnight. The council's Air Quality SPD contains detailed requirements regarding plug-in vehicle charging.
- 11.27 Future use of car parking facilities should be considered at the design stage. Future users may wish to convert garages, driveways and parking bays into gardens. Current designs therefore should not prevent conversion of car parking provision into another use.

Waste

- 11.28 Designs should consider arrangements for bin collections. Developments without collection areas can result in wheelie bins strewn across public areas until they are reclaimed by residents. The bins can represent a safety risk to pedestrians and vehicles, in addition to being visually unappealing.
- 11.29 Designs must have consideration for waste bin storage, which should include sufficient space to accommodate all the different types of bins used for waste and recycling collection as operated to households by the Council. Bin stores should be located no more than 25 m from the highway (where the bin collection lorry can park) for normal two-wheeled household bins.
- 11.30 Bin storage should not harm the visual amenity of the area; should be managed so that it does not create risk to water, air, soil, plants or animals; should not cause nuisance through odours; and should not affect the countryside or places of special interest.
- 11.31 Waste bin storage areas should be well ventilated and situated away from direct sunlight.

11.32 Communal waste/recycling facilities must be accessible to all residents regardless of bodily ability.

11.33 Developments should not provide for wheeled bins to be stored at the front of the property unless a design solution is proposed which significantly limits the impact of the storage of bins in the street scene.

11.34 The NHBC Foundation has produced guidance for waste bin storage for different types of housing entitled Avoiding Rubbish Design (2015). The guidelines by NHBC, which are set out below, can be used when designing spaces for waste bin storage.

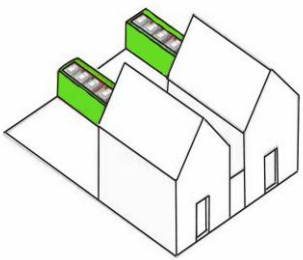
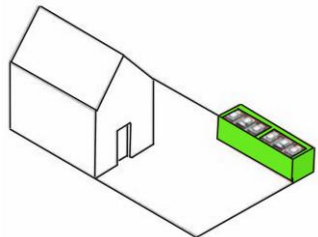
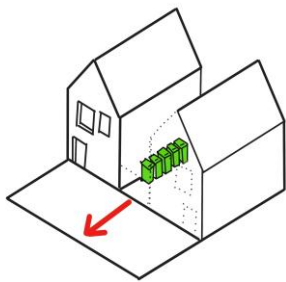
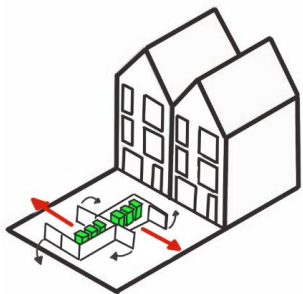
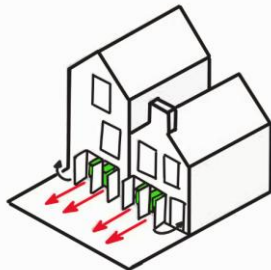
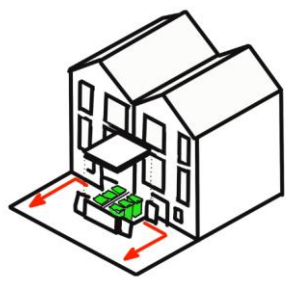
Semi-Detached Properties		
		
<p>Purpose built stores in rear of property. Bins kept where not visible from the house.</p>	<p>Purpose built stores to front of property along property boundary. Bins kept secure and screened from street.</p>	<p>Bin stored in space between detached houses. Space provided to allow the passing of bicycles and garden equipment. Gate provided at front of store.</p>
Linked Houses		
		

<p>Storage in front of houses. Bins are kept in purpose-built stores in front of houses along the property boundary. The dedicated storage area, which can be combined for pairs of houses as shown, keeps bins secure and discrete.</p>	<p>Storage behind garage-type doors. Particularly suited to mews-type buildings where there is little space at the front, this solution places the bins behind doors to the front of the houses. Care should be taken to ensure that the design of the facade is not overly dominated by too many doors.</p>	<p>Storage adjacent to front doors. Bins are kept in purpose-built stores adjacent to the front doors of the houses which can be constructed as pairs, as shown.</p>
---	---	---

Linked Houses

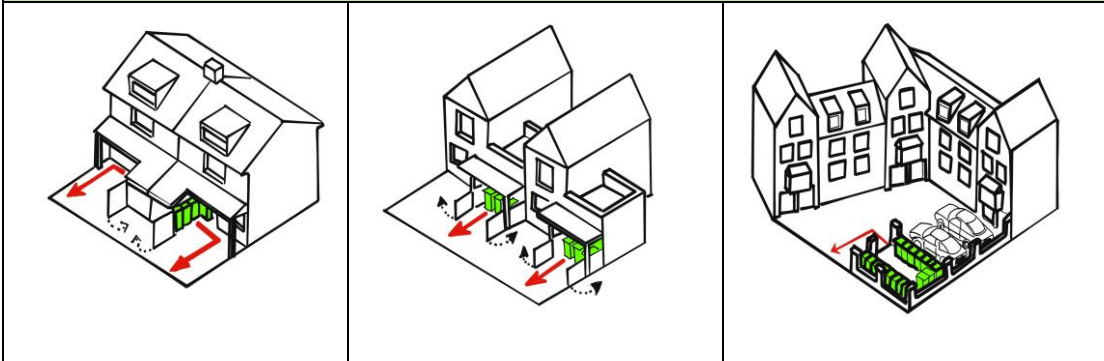

<p>Storage within storm porches. Storage adjacent to front doors integrates into a wider porch</p>	<p>Storage in front of courtyard houses. Like terraced houses, courtyard houses have restricted access from garden to street so there are few options for storage. In this example, bin stores fit under porches, with doors that open away from the house entrances.</p>	<p>Communal storage sited separately within shared grounds. Again, this solution provides open storage for a number of bins but it is located away from the houses. Due to the scale of the storage, consideration should be given to providing landscaping and/or screening to block residents' views of the bins. If possible,</p>
---	--	---

		the storage should be located close to the street boundary so that bins do not have to be wheeled out by residents on bin collection days.
Apartment Buildings		
		
<p>Communal storage within shared grounds adjacent to apartment buildings. This solution provides open storage for a number of bins. The preferred location is close to the street boundary so that bins do not have to be wheeled out by residents on collection days.</p>	<p>Communal storage to the side of apartment buildings. This solution provides a dedicated store to the side of the building in a logical position in relation to the entrance. The store should ideally use the same facing material as the building.</p>	<p>Communal storage within apartment buildings. Best suited to smaller apartment buildings, storage space for bins is provided within the envelope of the building. Ideally the storage space is discretely located but close to the building's access.</p>

Figure 21: Bin storage for various buildings¹⁵

¹⁵ NHBC Foundation (2015) *Avoid rubbish design: Providing bin storage on new housing developments*

Conversion of Non-Residential Buildings for Residential

11.34 The conversion of non-residential buildings for residential purposes should meet the following criteria.

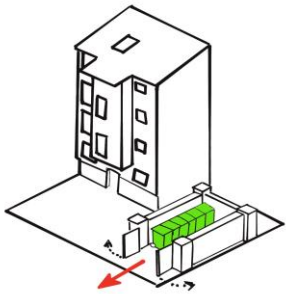
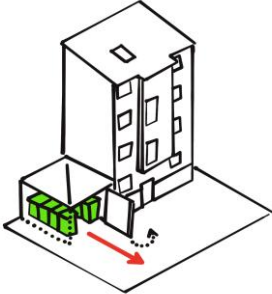
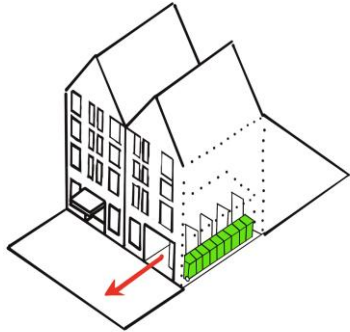
- a) The building must provide suitable living accommodation for the occupiers in terms of privacy, layout, design and impact from adjacent uses.
- b) There should be sufficient off-street parking for residents as specified in the Parking Standards SPD.
- c) The development of suitably located industrial/commercial premises should demonstrate that it is not viable to retain industrial/commercial use.
- d) The development should have provision for drying clothes outdoors.
- e) There should be adequate natural light within the property, with windows situated to allow occupants views of the outside environment (this does not include rooflights).
- f) External windows should not be shared between two internal rooms separated by walls.
- g) Windows should be located in the centre of internal walls, and should in no circumstances be near to / at the ends of internal walls.
- h) Adequate outdoor amenity space should be provided in line with the standards set out in this SPD.

Sub-Division of Dwellings to Self-Contained Units

11.35 The sub-division of a property into self-contained apartments should meet the following criteria.

- a) There should be adequate car parking within the curtilage of the building as specified in the Parking Standards SPD.
- b) There will be no negative impact on the amenity of adjacent properties.
- c) External amenity areas are accessible without passing through private rooms of other units.
- d) The development should not change the appearance of the building so that it is no longer in-keeping with the street scene.
- e) Adequate sound insulation should be provided to ensure the amenity of occupiers and surrounding residents is not unduly impacted.

- f) There should be adequate natural light within the property, with windows situated to allow occupants views of the outside environment (this does not include rooflights).
- g) External windows should not be shared between two internal rooms separated by walls.
- h) Windows should be located in the centre of internal walls, and should in no circumstances be near to / at the ends of internal walls.
- i) The development should have provision for drying clothes outdoors.
- j) Adequate outdoor amenity space should be provided in line with the standards set out in this SPD.

Change of Use from a Dwelling House to a House in Multiple Occupation

11.36 The change of use from a dwelling house to a house in multiple occupation should not be permitted unless the following criteria are met.

- a) Adequate sound insulation can be provided.
- b) An area for outside drying or measures for drying clothes can be provided.
- c) Adequate natural light is provided within the property, with windows situated to allow occupants views of the outside environment (this does not include rooflights).
- d) External windows should not be shared between two internal rooms separated by walls.
- e) Windows should be located in the centre of internal walls, and should in no circumstances be near to / at the ends of internal walls.
- f) Adequate outdoor amenity space is provided in line with the standards set out in this SPD.

12. Size and Arrangement

Internal Minimum Space Standards

12.1 In March 2015 the government set out a review of the housing standards resulting in a nationally described space standard. The minimum residential space standards to follow are found in the document "Technical housing standards - nationally described space standard" (2015) published by the Department for Communities and Local Government.

12.2 An overview of the space standards is provided in Table 2. The total floor space is measured between the internal faces of perimeter walls that enclose a dwelling. It includes cupboards, partitions, flights of stairs, voids above stairs and structural elements.

Table 2: Minimum gross internal floor areas and storage (m²)¹⁶

Number of Bedrooms	Number of bed spaces (persons)	1 storey dwellings	2 storey dwellings	3 storey dwellings	Built-in storage
1b	1p	39 (37)*			1
	2p	50	58		1.5
2b	3p	61	70		2.0
	4p	70	79		
3b	4p	74	84	90	2.5
	5p	86	93	99	
	6p	95	102	108	
4b	5p	90	97	103	3.0
	6p	99	106	112	

¹⁶ Department for Communities and Local Government (2015) *Technical housing standards – nationally described space standards*

	7p	108	115	121	
	8p	117	124	130	
5b	6p	103	110	116	3.5
	7p	112	119	125	
	8p	121	128	134	
6b	7p	116	123	129	4.0
	8p	125	132	138	

Notes: *Where a one person dwelling has a shower room instead of a bathroom, the floor area may be reduced from 39 m² to 37 m², as shown bracketed.

12.3 Developers should provide floor areas for development schemes which meet or exceed the space standards.

Internal Layout

12.4 The internal layout of dwellings should enable flexibility of use by the occupant/s.

12.5 To create habitable rooms with adequate daylight, ceiling heights measured from the floor should be a minimum of 2.5 m.

12.6 Single aspect flats should demonstrate that all habitable rooms and kitchen areas provide adequate daylight, privacy and ventilation.

13. Built Form

13.1 The borough has developed over several distinctive phases. The broad phases of development are represented in figure 22.

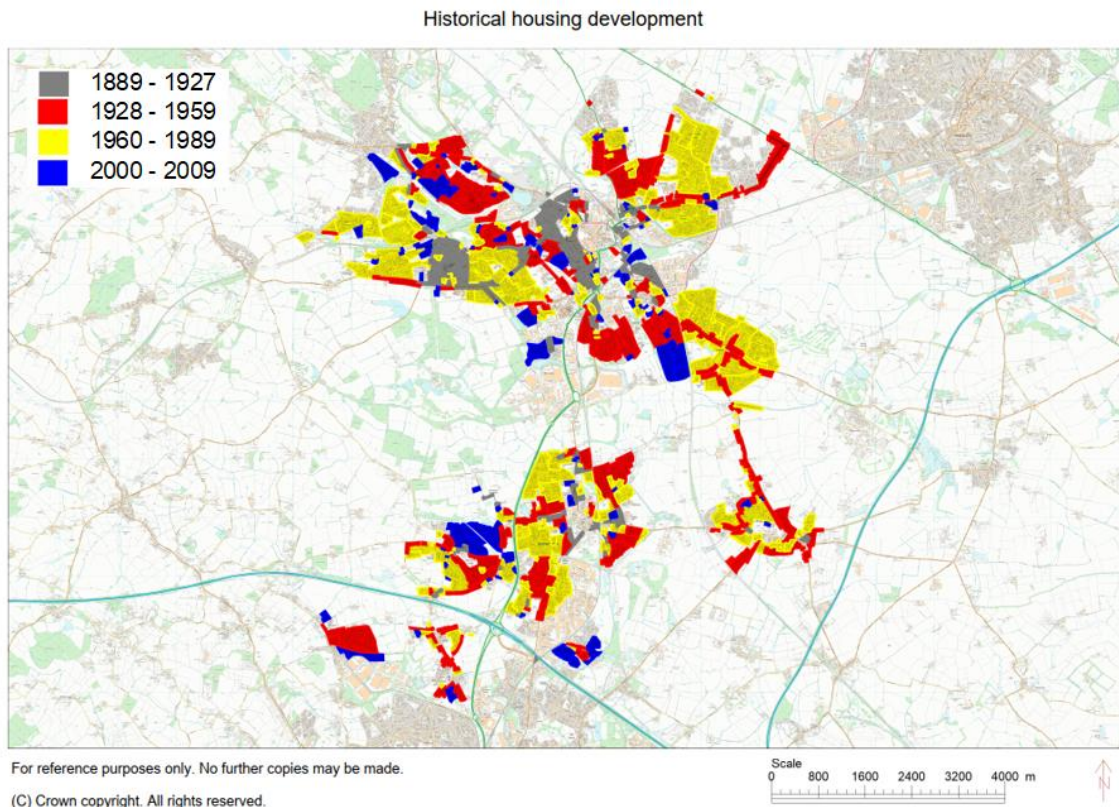

Figure 22: Development stages in Nuneaton and Bedworth Borough

13.2 Designs should have regard to the urban characteristics of the locality, adding to its distinctiveness in a sympathetic way. Character, materials and detailing inspiration for proposals should be drawn from the local context. Proposals should avoid departing from local characteristics unless the proposals are of a high quality or of an innovative design. In this context, a high quality or innovative design should:

- help raise standards of design more generally in the area;
- reflect high standards in architecture; and
- enhance its immediate setting

Nuneaton and Bedworth’s Residential Character

- 13.3 The document “Nuneaton & Bedworth Urban Characterisation: Detailed Generic Character Type Descriptions and Design Policies” identified specific characteristics of dwellings in the borough, based on their predominant generic character type.

Table 3: Predominant generic character types

Late 19th/Early 20th Century Artisan Urban Terrace Housing (Predominantly located in the highlighted grey areas of the map)
Industrial character - red brick and tile terraces and/or short rows of 4 to 6 houses.
Located close to urban centres and former major factory, quarry, and mine sites – marking rapid turn of the 20th century urban expansion due to coal mining, brick and tile making, and railway development.
Form dictated by building by-laws to safeguard health and hygiene.
Straight road alignments, often in grid pattern.
Two storey buildings, with consistent eaves and ridge heights. Consistent building lines, either to back edge of footpath or behind small enclosed forecourts.
Locally produced brick and tile often used.
Short and narrow rear gardens/yards.
Little greenery – hard urban feel.
Frontages often subject to adverse alteration - stone cladding, unsympathetic replacement materials, windows and doors, etc.
On-street car parking.
Sensitivity to Change: High Despite adverse past change, the highly consistent nature of terraces and their high density means that redevelopment would

be disruptive to coherence and unity of the historic character and local distinctiveness of the area.

Inter-war Speculative Residential Ribbon & Estate Development (Predominantly located in the highlighted red areas of the map)

Linear development along major roads, or estates with crescents, cul-de-sacs and/or rectangular block road layouts.

Characteristic house-types predominantly semi-detached pairs of houses, with compact rectangular forms and mostly with hipped clay tile main roofs.

Better quality houses have two-storey bays (rectangular or semi-circular) beneath a projecting gabled roof to the front. The latter often have applied mock-timber framing.

Grass verges and trees often separate footpath from road.

Side access used for car parking / car port / garage.

Houses of the same or very similar form with minor variations of detail.

Sensitivity to Change: Medium
Consistent and highly characteristic nature of building types means that redevelopment of individual buildings could be disruptive to coherence and unity of the character and appearance of the area as a whole.

Post-war Private Residential Estate (Predominantly located in the highlighted yellow areas of the map)

Private speculative lower-middle-class housing of the late 1950s to late 80s.

Low to medium density semi-detached and close and linked-detached.

Anglo-Scandinavian style (a style adopted nationally) common 1960 to 70s - shallow-pitched roofs in concrete tile, large

horizontally proportioned 'picture' windows, non-local brick often pale in colour, tile hanging and horizontal timber board cladding in panels on front elevations. Neo-vernacular style in 1980s.
Little variety of house types within streets and estate as a whole.
Cul-de-sac layouts common.
Small front gardens either with dwarf walls or without enclosure to pavements.
Integral garages and forecourt parking.
Sensitivity to Change: Medium Repetitive nature of building types with little variation within streets means that redevelopment of individual buildings may weaken the coherence and unity of the character and appearance of the area as a whole. However, individual designs and the materials used are usually undistinguished, and some redevelopment over a wider area could introduce some welcome variety.

- 13.4 Where developments are located in the vicinity of a predominant generic character type, the corresponding development advice contained in table 3 should be followed.
- 13.5 Where there are diverse architectural styles, there should be early discussion between applicants, the local planning authority and local community about the design. Applicants should provide evidence of pro-active engagement with the community regarding development of the overall design. Evidence should demonstrate effective input from the community and how the views of the community have been incorporated into the final design.
- 13.6 The Council will view proposals which have clear community involvement more favourably than those with no community involvement.
- 13.7 In all cases, the scale, texture and colour of building materials and method of building should work individually and for the area as a whole.
- 13.8 Development proposals which are located in defined landscape character areas should follow Policy NE5 - Landscape Character¹⁷.

¹⁷ FPCR Environment and Design (2023) *Nuneaton and Bedworth Landscape Character Assessment*

Proposals should conserve and where appropriate enhance the landscape.

Table 4: Nuneaton and Bedworth landscape character areas

LCA1: Hartshill Ridge	LCA7: Keresley Urban Fringe
LCA2: Anker Valley Estate Farmlands	LCA8: Keresley Newlands Ancient Arden
LCA3: Nuneaton Estate Farmlands	LCA9: Bedworth Woodlands Rural Fringe
LCA4: Bulkington Rolling Farmland	LCA10: Arbury Parklands
LCA5: Bulkington Village Farmlands	LCA11: Galley Common Hills and Robinson's End Valley
LCA6: Nuneaton and Bedworth Urban Fringes	LCA12: Galley Common Hills and Valleys
LCA13: Whittleford Park and Bar Pool River Valley	

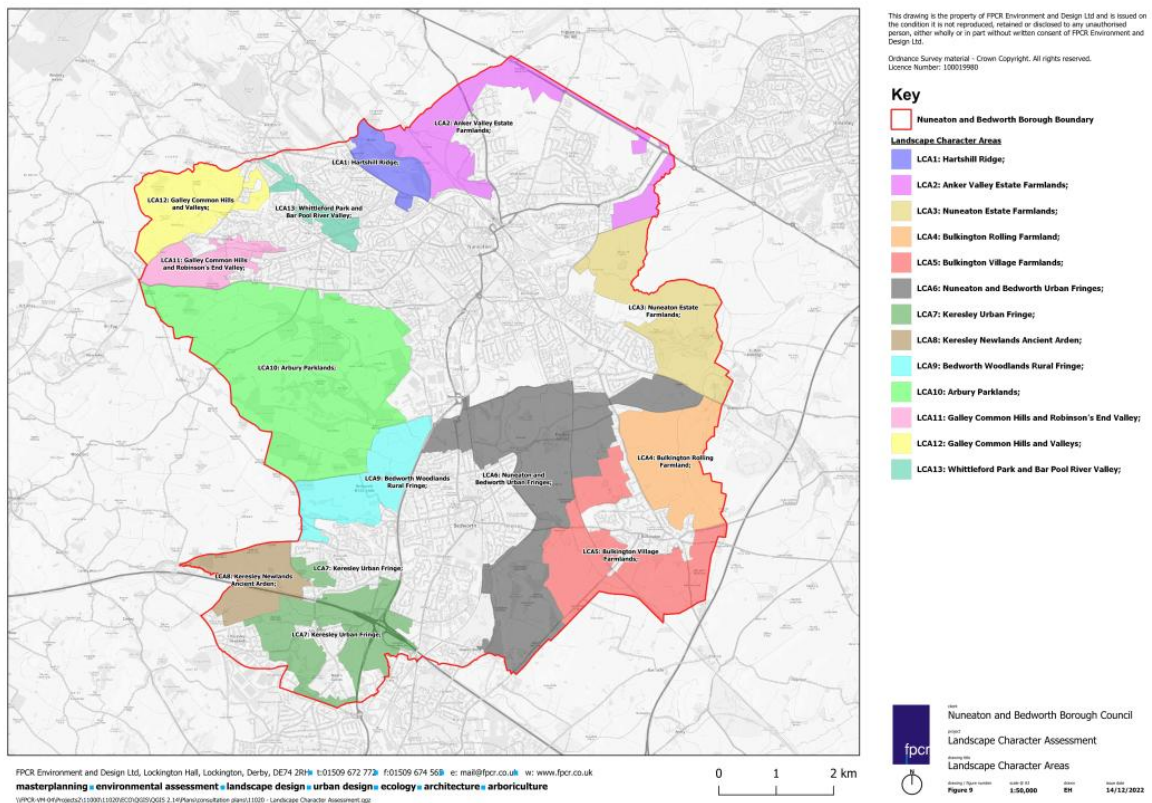

Figure 23: Map of Nuneaton and Bedworth landscape character areas

Extensions and Alterations to Existing Houses

13.9 Extensions and alterations should respect the form and size of the original building.



Figure 24: Extensions which are in keeping with the design and scale of the existing house and the group within which it is sited

13.10 It should be in harmony with the design, character and layout of the property and surrounding area.

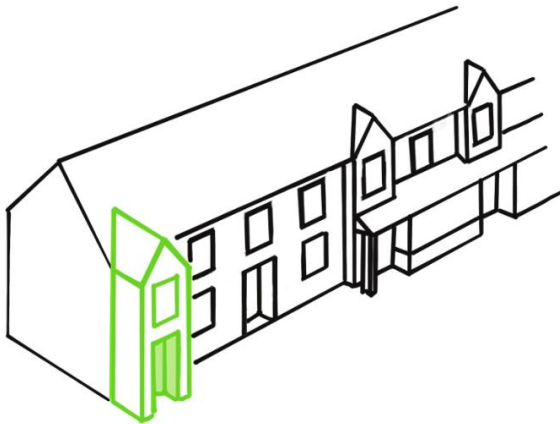

Figure 25: Extensions which are in keeping with the design and scale of the existing house and the group within which it is sited

13.11 Extensions and alterations should not dominate the existing house by projecting above the ridge line. Additionally, they should not appear intrusive, prominent or incongruous in the street scene or from public areas.

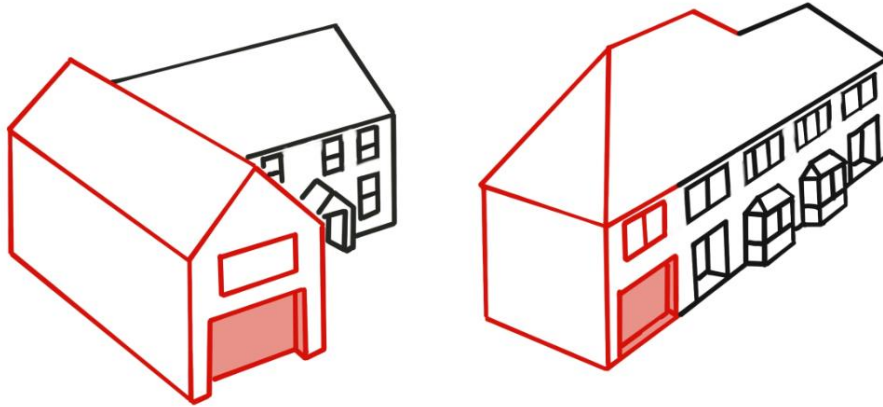

Figure 26: Extensions which are in keeping with the design and scale of the existing house and the group in which it is sited



Figure 27: An intrusion in the street scene

13.12 Care should be taken to ensure that extensions and alterations do not result in large blank elevations visible in the street scene.

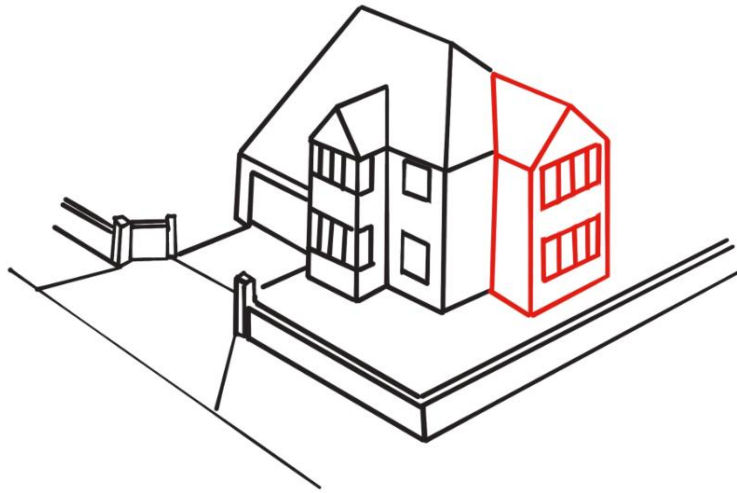

Figure 28: Extension designed with a double frontage effect

13.13 Another aspect which should be avoided is to introduce a roof or dormer window that fails to match or reflect the original property in design, angle of pitch and materials. A possible exception to this is the transformation of a bungalow into a two-storey house in an area characterised by similar houses.



Figure 29: Extensions unsympathetic to the original roof form of the house

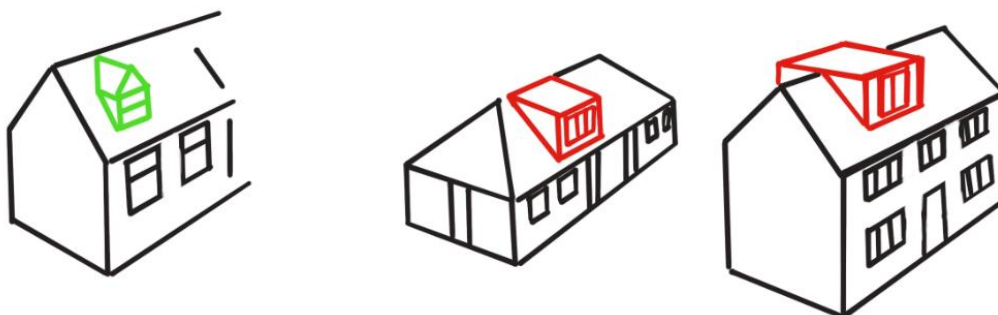

Figure 30: Good dormer design on left. Unsatisfactory dormer designs not fitting into roof form on right

13.14 External finishes used on extensions should match originals. Where it is unlikely a good match of materials can be achieved, consideration should be given to setting back the extension behind the front elevation (e.g. a minimum 0.5 m back). Felt, plastic or asbestos sheeting should not be used on pitched roofs.

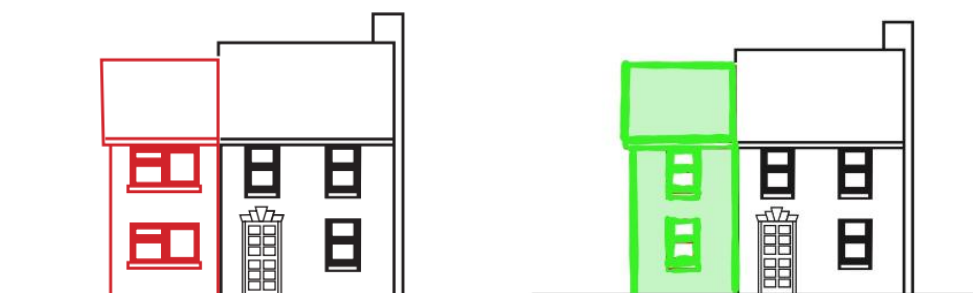

Figure 31: Existing character spoilt by unsympathetic windows in extension on left; character retained by using windows in keeping with original on right

13.15 New extensions and alterations should avoid the removal of well-established trees.

13.16 New extensions should not reduce the car parking provision of the existing house to the extent where significant on-street parking may result.

Industrial, Storage and Distribution Development

- 13.17 In the interests of visual amenity, all industrial, storage and distribution developments should ensure they do not create an oppressive or incongruous environment. Unless building design is high quality and innovative, any cladding should be coloured light blue in order to reduce the oppressive nature of the development's mass. The use of light blue cladding will blend more sympathetically with the skyline than other colours, therefore other colours should be avoided. This is for visual amenity in all locations, however it is particularly necessary where this form of development is located in close proximity to dwellings, as it will be required for residential amenity, preventing the unpleasant appearance of a permanently oppressive outlook from both dwellings and their gardens.
- 13.18 In addition to the design of cladding, where there is sufficient open space on site, planting should be used to break up the large mass of industrial, storage and distribution development. Again, this will benefit both wider visual amenity, and residential amenity for dwellings in close proximity to such developments.

Part B: Major Residential Development

14. Building for a Healthy Life

- 14.1 Building for a Healthy Life (BHL) is a design toolkit for designing neighbourhoods, streets, homes and public spaces. The toolkit is endorsed by Homes England among others, and reflects the requirements of both the National Planning Policy Framework and National Design Guide. BHL is composed of 12 considerations to help facilitate discussions between developers, communities, the local planning authority and other stakeholders.
- 14.2 BHL uses a red, amber and green light structure. Applicants should aim to achieve green lights against each criteria for each of the 12 considerations. There may be circumstances where local context means it is not possible to achieve all green lights. In these cases developers should endeavour to achieve as many green lights as possible. A statement of justification will be required explaining why the criteria cannot be met if the applicant feels this is the case. This should state what has been done to mitigate the problem presently, and demonstrate ways that developments may meet the criteria in the future.
- 14.3 A copy of Building for a Healthy Life: A Design Toolkit for neighbourhoods, streets, homes and public spaces (Design for Homes, 2020) can be found on the Design for Homes website.

15. Greywater Recycling

- 15.1 The residential section of Policy BE3 sets out that major development proposals must provide a statement with their application showing how their proposal will install greywater recycling systems in the curtilage of all new buildings. However, the section entitled, "If the policy requirements cannot be met", states that where a developer considers meeting this requirement is unviable or can demonstrate that it is not suited to local circumstances, supporting evidence must be provided with any planning application to clearly demonstrate this.
- 15.2 This policy requirement is informed by the Coventry and Warwickshire Sub-regional Water Cycle Study – Stage 1 (JBA, 2024), which states that larger residential developments should consider incorporating greywater recycling into development at the master planning stage to reduce water demand. However, the study does note that greywater recycling systems require more treatment and are more complex than rainwater harvesting systems, with limited examples of their use in the UK. Further to this, these systems require a much higher level of maintenance than rainwater harvesting or greywater re-use systems. The study also has regard to the cost of greywater recycling systems set out in the "Independent review of the costs and benefits of rainwater harvesting and greywater recycling options in the UK" (Waterwise, 2020).
- 15.3 If a developer considers greywater recycling is unviable or not suited to local circumstances, the above information from the study could be used as supporting evidence to demonstrate this.
- 15.4 Referring back to Policy BE3, the section entitled "If the policy requirements cannot be met" also outlines that an independent viability assessment is likely to be the most appropriate assessment to demonstrate that greywater recycling is unviable. However in the case of greywater recycling, an independent viability assessment will not be required, as the Waterwise document sets out the cost of greywater recycling, which could be used in a simple calculation against the building costs for an application in order to demonstrate that greywater recycling is unviable.

16. Passive Solar Design

16.1 Passive Solar Design (PSD) responds to local climate and site conditions to maximise amenity for occupants and minimise energy use. PSD works by allowing heat into buildings during winter months and blocks out the sun during summer months. Techniques include shading mechanisms, implementing large south-facing windows and using building materials that absorb and slowly release the sun's heat.

Passive Solar Design - Building Orientation

16.2 The orientation of the building affects the amount of solar gain experienced. Houses do not all need to face directly south to gain the benefits of solar gain, but should be orientated within 30° of a directly southerly direction where possible. A southeasterly orientation is the best orientation overall as it will make effective use of the early morning gains, and reduce the likelihood of overheating in the afternoon.

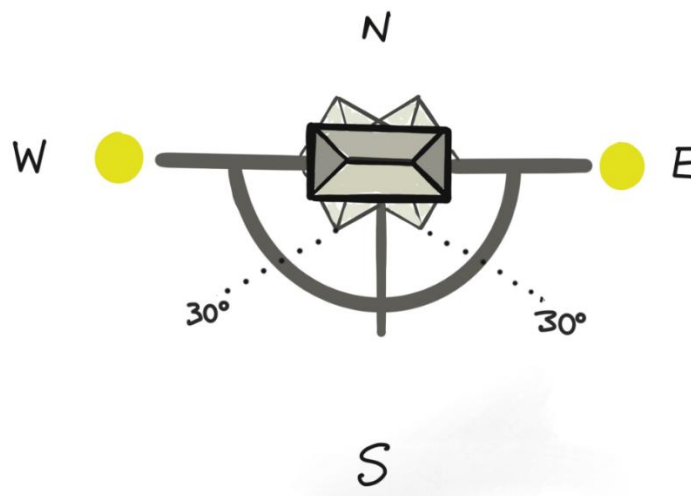

Figure 32: Passive solar design building orientation

16.3 Road layout is an important factor in PSD as it determines building orientation. Roads which run on an east to west axis will provide more opportunity to position homes to take advantage of solar gain. There are design solutions for roads which by necessity run north to south such as diagonal roads, plots re-orientated to face the road, or re-orientating the houses within the plots. However, the need for

building orientation to meet PSD standards should be balanced by the need to create an acceptable pattern of development.

- 16.4 Consideration should be given to the proximity of other buildings in order to limit the possibility of overshadowing. Lower buildings such as bungalows should be located to the south with taller buildings to the north. Non-habitable areas such as garages should be positioned to the north.



Figure 33: Building size location in relation to sun

- 16.5 Trees can be planted to help protect settlements from prevailing winds. The tallest trees should be deciduous to allow the winter sun. Trees can be used to protect settlements from winter northeasterly winds, and in this case, trees should be evergreen. Decorative trees that will eventually grow above the shadow line should be deciduous.
- 16.6 Warwickshire County Council are responsible for the roads and highways in the borough that are maintained at public expense, and must be consulted with regards to any proposals that may affect existing trees within the adopted highway, or any proposed tree planting within streets intended to be offered for adoption.



Figure 34: Tree function in Passive Solar Design

Passive Solar Design - Room Layout

16.7 The most frequently used rooms such as the living room and main bedrooms should be positioned on the south side of the dwelling. Rooms that benefit little from sunlight, such as hallways, utility rooms, bathrooms and storage areas should be placed on the north side of the dwelling. To minimise overheating in the kitchen, south-facing glazing should be avoided.

Passive Solar Design – Glazing

16.8 A passive solar house normally has more glazing on the south elevation to capture the heat, and smaller windows on the north to prevent heat escaping. The southern elevation should incorporate a greater percentage of glazing than other elevations. The northern elevation should have smaller glazing to minimise heat loss.

16.9 PSD considerations should not negatively impact on the natural surveillance provided by the dwelling, nor affect daylight within the dwelling.

Passive Solar Design - Thermal Mass

16.10 Thermal mass refers to the capacity to absorb, store and release heat. Heat radiated onto a surface is absorbed, then conducted from the warm surface to the cooler interior of the mass. When the surface becomes warmer than the surrounding air, the heat is

radiated back into space, warming the air and the surface becomes cooler.

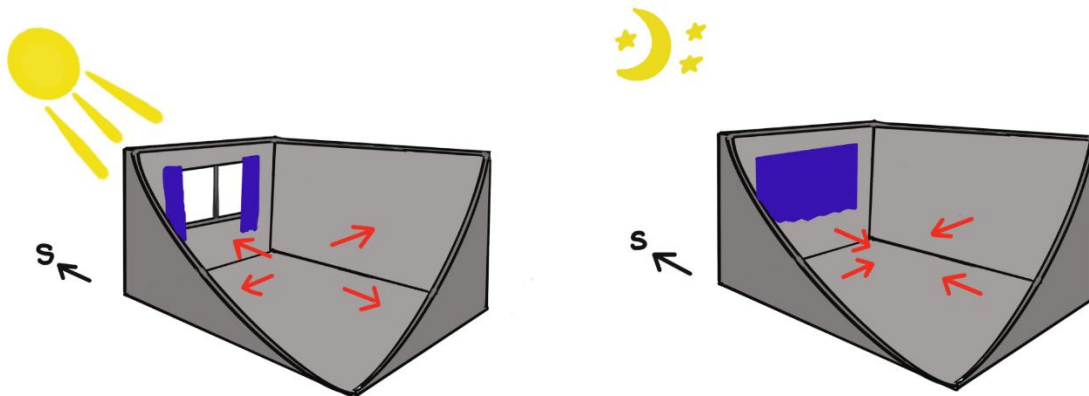

Figure 35: Thermal mass: absorbing and releasing heat

16.11 An effective thermal mass material must have high heat capacity, moderate conductance and density, as well as high emissivity and absorptivity. Building materials which may appear to be similar can have different levels of absorption, for example a building material with a reflective surface will absorb less heat than a similar material with a dull surface. Effective thermal mass is reliant on three factors: specific heat capacity, density and thermal conductivity.

Table 5: Thermal mass components

Specific heat capacity	The amount of heat energy absorbed per kilogram of material.
Density	The amount of kilograms of material per volume. High density means more energy can be absorbed.
Thermal conductivity	The rate energy flows in and out of material.

16.12 Normally, only the first 100 mm depth of dense material will absorb heat from the air. If the dense material is not in direct contact with the air (coupling), the effect is reduced. For example, the use of plasterboard instead of wet plaster produces an air space which limits the ability of brickwork to absorb heat. Table 7 shows admittance values for different building constructions based on data from the Energy Savings Trust. The table is for illustrative purposes, however it shows designers relative differences between

construction materials. The admittance of a material gives an indication of how efficiently a building element can absorb thermal gains, and is expressed in W/m^2K (watts per square metre kelvin)¹⁸.

Table 6: Admittance values for building constructions

	Construction	Admittance (Y) W/m^2K
External Walls	Dense block,13 mm wet plaster	5.89
	Aircrete block,13 mm wet plaster	2.86
	Dense block,13 mm plasterboard on dabs	2.6
	13 mm plasterboard + 13 mm wet plaster on timber frame wall	1.9
	Aircrete block,13 mm plasterboard on dabs	1.85
	Two layers 13 mm plasterboard on timber frame wall	1.45
	Single layer 13 mm plasterboard on timber frame wall	0.85
Party Walls	Dense block,13 mm wet plaster	5.66
	Dense block,13 mm plasterboard on dabs	2.61
	Aircrete block,13 mm wet plaster	2.58
	Aircrete block, 13 mm plasterboard no dabs	2.11

¹⁸ Ward, T., Hannah, G. and Sanders, C. (2016) *Conventions for Calculating Linear Thermal Transmittance and Temperature Factors (BR 497 2nd edition)*

	13 mm plasterboard plus 13 mm wet plaster on timber frame wall	2.08
	Aircrete block,13 mm plasterboard on dabs	1.73
Internal Partition	Two layers 13 mm plasterboard on timber frame wall	1.62
	Dense block,13 mm wet plaster	5.06
	Dense block,13 mm plasterboard on dabs	2.67
	Aircrete block,13 mm wet plaster	2.53
	Aircrete block,13 mm plasterboard no dabs	2.05
	13 mm plasterboard plus 13 mm wet plaster timber frame wall	2.01
	Aircrete block,13 mm plasterboard on dabs	1.81
	Two layers 13 mm plasterboard on timber frame wall	1.55
Ground Floor	Fair-faced aircrete block	1.54
	Single layer 13 mm plasterboard on timber frame wall	0.86
	Insulation, concrete slab, wood blocks	3.37
	Concrete slab, insulation, chipboard, wood blocks	2.68

	Beam and medium density block floor, insulation chipboard, wood blocks	2.67
	Beam and aircrete block floor, insulation, chipboard, wood blocks	2.67
	Insulation, concrete slab, screed, wood blocks	2.63
	Insulation, concrete slab, underlay and carpet	1.81
	Beam and aircrete block floor, insulation, chipboard, underlay, laminate flooring	1.65
Ground Floor Ceiling	Concrete slab, insulation, chipboard, underlay and carpet	1.59
	Beam and medium-density block floor, insulation, chipboard, underlay and carpet	1.59
First Floor (floor)	Beam and aircrete block floor, insulation, chipboard, underlay and carpet	1.58
	20 cm timber joist internal ceiling; 22 mm wood blocks	0.8
	20 cm timber joist internal ceiling; laminate flooring and underlay	0.81
	20 cm timber joist internal ceiling, carpet and underlay	0.81
	20 cm timber joist internal ceiling; 22 mm wood blocks	0.9

	20 cm timber joist internal ceiling; laminate flooring and underlay	0.88
	20 cm timber joist internal ceiling, carpet and underlay	0.88

16.13 Modern Methods of Construction (MMC) utilise non-traditional methods of construction in the development of modular homes. The downside is the materials used can have less efficient thermal mass in relation to traditional building methods. MMC applications should indicate in the planning statement the efforts made to increase the thermal mass of the development, for example using a dry-lining boarding with a much higher density than normal plasterboard. As the industry develops, performance of building materials may increase due to the need to provide energy efficiency, and applicants should utilise proven new techniques to increase thermal mass.

16.14 Full or reserved matters application statements should provide justification for the choice of building materials used, and how the chosen materials are beneficial to thermal mass. In the case of outline applications, a planning condition should require the statement be provided at the reserved matters stage.

Passive Solar Design - Passive Ventilation

16.15 The fabric of a building has limited capacity to hold heat, therefore in periods of high temperatures, cooling techniques may be necessary to reset capacity. Passive ventilation should be considered with passive solar design¹⁹.

¹⁹ Dengel, A., Swainson, M., Ormandy, D. and Ezratty, V. (2016) *Overheating in Dwellings*

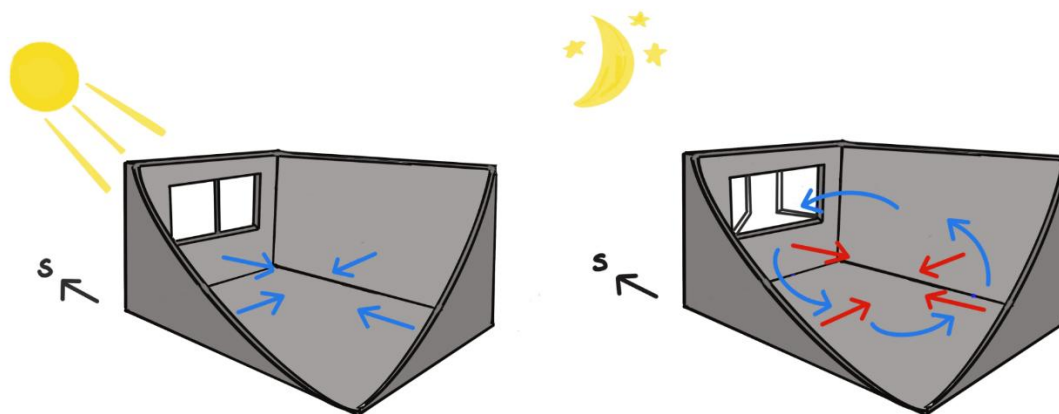

Figure 36: Thermal mass and ventilation

- 16.16 There is no internationally recognised definition of overheating, mainly as the impacts are determined by localised climatic conditions. According to the World Health Organisation (WHO), temperate climates above 24°C cause discomfort.
- 16.17 Temperatures exceeding 25°C may give rise to significant health problems, including increased incidences of strokes and mortality. The groups most vulnerable include the elderly; those with chronic physical illnesses such as diabetes, heart conditions and obesity; and those taking certain medications. The risk increases with lack of mobility.
- 16.18 The need for energy efficient buildings and highly insulated air-tight dwellings can result in the unintended effect of internal overheating. Energy efficient dwellings limit the heat loss through the fabric and insulation, retaining more of the internal and solar heat gains within the dwelling²⁰.
- 16.19 Ventilation strategies should be utilised which consider the effects of climate change and mitigate against extreme thermal temperatures as a result of anticipated hotter summers.
- 16.20 It is important to consider the site context in relation to ventilation strategies. The close proximity of noisy roads or industrial activities may discourage occupants from opening windows. Provision of secure ventilation is important in areas where it is not practical or desirable for occupants to open windows.

²⁰ NHBC Foundation (2012) *Understanding Overheating - Where to Start*, and NHBC Foundation (2012) *Overheating in New Homes*

16.21 Single aspect flats provide limited possibility for ventilation and should be avoided. Proposals for single aspect flats should demonstrate that all habitable rooms and kitchens provide adequate ventilation.

16.22 Full or reserved matters application statements should include justification of the ventilation strategy to be adopted in the proposed design. In the case of outline applications, a planning condition should require the statement to be provided at the reserved matters stage.

Passive Solar Design – Statement

16.23 Where the council have doubts regarding the robustness of the Passive Solar Design statement, the council will require the statement to be resubmitted by an independently accredited sustainability professional.

17. Secured By Design

- 17.1 The creation of secure spaces is one of the most important aspects in designing places where people wish to live, work and visit. Secured By Design (SBD) supports the principles of designing out crime through incorporating the use of effective crime prevention and security standards into designs.
- 17.2 SBD has been produced by the Association of Chief Police Officers (ACPO) and is supported by the Home Office.
- 17.3 The SBD Residential Guide (2025)²¹ addresses the community safety, environmental factors (including public realm and communal provision) and physical security requirements for all types of dwellings, including individual houses, housing estates, and low and high rise apartment blocks.
- 17.4 The design, layout and physical security sections of SBD Homes can be applied to both new and refurbished homes.
- 17.5 All major developments should reduce the opportunity for crime and the fear of crime by following the relevant “Secured by Design” design guide.
- 17.6 The application should include a statement demonstrating where the principles of SBD have been incorporated into the design.
- 17.7 The following sub-sections highlight some of the key principles which the council consider need to be taken into account in all major residential development proposals as set out in Secured By Design²².

Through Roads and Cul-de-Sacs

- 17.8 Development layouts should not allow the criminal legitimate access to the rear or side boundaries of dwellings, and therefore use perimeter blocks. Development should also avoid unnecessary segregated footpaths, with footpaths situated at the front of dwellings.

²¹ Secured By Design (2025) *Residential (Homes) Guide 2025*

²² Secured By Design (2025) *Residential (Homes) Guide 2025*

17.9 In relation to cul-de-sacs, research shows that the benefit of cul-de-sacs can be compromised if one or more of the following undesirable features exists.

- Backing onto open land, railway lines, canal towpaths, etc.
- Are very deep (long)
- Linked to one another by footpaths (leaky cul-de-sacs)
- Poorly lit

17.10 With regard to leaky cul-de-sacs, which are cul-de-sacs that connect by footpaths to other parts of a development, evidence has shown that these experience the highest levels of crime when compared to crime levels within a true cul-de-sac. Crime in this kind of design can be 110 % higher than crime in a true cul-de-sac and therefore should be avoided.

Footpath and Bicycle Route Design

17.11 Public footpaths should not run to the rear of, and provide access to, gardens, rear yards or dwellings as these have been proven to generate crime.

17.12 Where a segregated footpath is unavoidable, for example where there is a public right of way, an ancient field path or heritage route, designers shall make the footpath a focus of the development by ensuring it is a safe space and accessible for all.

17.13 A segregated footpath should be:

- As straight as possible
- Wide
- Well-lit
- Devoid of potential hiding places
- Overlooked by surrounding buildings and activities
- Carefully landscaped
- Well-maintained so as to enable natural surveillance along the path and its borders

17.14 Where isolated footpaths are unavoidable, and where space permits, they shall be at least three metres wide (to allow people to pass without infringing personal space and to accommodate passing wheelchairs, bicycles and mobility vehicles).

17.15 Where footpaths run next to buildings or roads, the path shall be open to view.

Communal Areas and Play Spaces

17.16 Open spaces must have features which prevent unauthorised vehicular access. Another aspect of particular consideration is that the positioning of public amenity / play spaces to the rear of dwellings can increase the potential for crime and complaints arising from increased noise and nuisance.

Layout and Orientation of Dwellings

17.17 Dwellings should be positioned facing each other to allow neighbours to easily view their surroundings, leading to increased natural surveillance, community interaction and engagement, therefore making potential offenders feel vulnerable to detection.

Gable End Walls

17.18 It is important to avoid the creation of windowless elevations and blank walls immediately adjacent to public spaces. This type of elevation, commonly at the end of a terrace, tends to attract graffiti, inappropriate loitering and potential anti-social behaviour, such as continually kicking a football against a wall. The provision of at least one window above ground floor level, where possible, will offer additional surveillance over the public area.

17.19 Where blank gable walls are unavoidable, one of the following methods shall be used to protect them.

- Provide a 1 m buffer zone using either a 1.2 to 1.4 m railing (with an access gate) or a 1 m mature height hedge with high thorn content. Hedging will have to be protected with a fence until it becomes established. The hedge shall be contained within the boundary of the adjacent building to increase the likelihood that it will be maintained.

- Where there is insufficient room to create a defensible space between public and private space, an appropriate (non-destructive) climbing plant shall be planted adjacent to the wall, or a finish applied to the wall that will allow easy removal of graffiti.

Vehicle Parking

17.20 Where communal parking areas are necessary, bays shall be sited in small groups, close and adjacent to homes, be within view of action rooms, and clearly marked, so that it is obvious which parking spaces belong to which dwellings.

17.21 In relation to active rooms, the word active in this sense means rooms in the building elevations from which there is direct and regular visual connection between the room and the street or parking court. Such visual connection can be expected from rooms such as kitchens and living rooms, but not from more private rooms, such as bedrooms and bathrooms.

17.22 Looking at rear parking courtyards, these are discouraged for the following reasons.

- They introduce access to rear elevations, which may leave dwellings vulnerable to burglary
- In private developments, such areas are often left unlit and therefore increase the fear of crime
- Ungated courtyards provide areas of concealment which can encourage anti-social behaviour

17.23 When it comes to the positioning of garages, locating these forward of the building line can obscure views to and from the dwelling, therefore this should be avoided.

17.24 Where parking is designed to be adjacent to or between units, a gable end window will provide residents with an unrestricted view over their vehicles; opaque or otherwise obscured glass in gable end windows do not constitute an unrestricted view in these circumstances.

17.25 Parking bays should ideally benefit from good natural surveillance, for example being overlooked by the clear windows of public

buildings and private dwellings. A location with good footfall is also desirable, to ensure there are sufficient people nearby who may notice suspicious activity and contact police. Bays that are either secluded, enclosed, or sited on their own within traffic islands, can be targeted because there are no passing pedestrians or vehicles to deter crime. Surrounding buildings with opaque or transfer covered windows will also provide little benefit.

18. Air, Soil, Noise and Light Pollution

Air Pollution

- 18.1 Air Pollution has harmful effects on health and the environment. The major source of air pollutants are from combustion, space heating, power generation and from motor vehicles. Elevated levels or long-term exposure to air pollution can lead to conditions which are harmful to human health.
- 18.2 There is currently one Air Quality Management Area in the Borough due to exceedances of the annual mean nitrogen dioxide (NO₂), predominantly due to emissions from road traffic. This is located at Midland Road.
- 18.3 Developers should consult Nuneaton and Bedworth Borough Council's Air Quality Supplementary Planning Document for guidance.

Noise Quality

- 18.4 There are statutory provisions for noise, including the Control of Pollution Act 1974 which concerns construction site noise, as well as legislation for statutory nuisance such as the Environmental Protection Act 1990. Planning practice guidance for noise states, "noise is a planning consideration when new developments may contribute towards noise, when new developments may be sensitive to noise, and/or when new developments make it possible to improve the acoustic environment".
- 18.5 Table 8, reproduced from Planning Practice Guidance on noise at paragraph 005, provides a useful guide for developers to consider if proposals are likely to be a noise concern. There are a number of factors which will impact upon how noise is experienced, for example the time of day at which the noise occurs, the frequency and pattern of noise, and the pitch of noise.

Table 7: Noise levels²³

Response	Example of outcomes	Increasing effect level	Action
No Observed Effect Level			
Not present	No effect	No Observed Effect	No specific measures required
No Observed Adverse Effect Level			
Present and not intrusive	Noise can be heard, but does not cause any change in behaviour, attitude or other physiological response. Can slightly affect the acoustic character of the area but not such that there is a change in the quality of life.	No Observed Adverse Effect	No specific measures required
Lowest Observed Adverse Effect Level			
Present and intrusive	Noise can be heard and causes small changes in behaviour, attitude or other physiological response, e.g. turning up volume of television; speaking more loudly; where there is no alternative ventilation, having to close windows for some of the time because of the noise. Potential for some reported sleep disturbance. Affects the acoustic character of the area such that there is a small actual	Observed Adverse Effect	Mitigate and reduce to a minimum

²³ Ministry for Housing, Communities and Local Government (2025) *Noise: Paragraph 005 (Noise exposure hierarchy table)*

	or perceived change in the quality of life.		
Significant Observed Adverse Effect Level			
Present and disruptive	The noise causes a material change in behaviour, attitude or other physiological response, e.g. avoiding certain activities during periods of intrusion; where there is no alternative ventilation, having to keep windows closed most of the time because of the noise. Potential for sleep disturbance resulting in difficulty in getting to sleep, premature awakening and difficulty in getting back to sleep. Quality of life diminished due to change in acoustic character of the area.	Significant Observed Adverse Effect	Avoid
Present and very disruptive	Extensive and regular changes in behaviour, attitude or other physiological response and/or an inability to mitigate effect of noise leading to psychological stress, e.g. regular sleep deprivation/awakening; loss of appetite, significant, medically definable harm, e.g. auditory and non-auditory.	Unacceptable Adverse Effect	Prevent

Noise Criteria

18.6 The Noise Policy Statement for England (NPSE)²⁴ uses the following terms regarding the effects of noise:

Table 8: Effects of noise²⁵

No Observed Effect Level (NOEL). The level below which no effect can be detected. In simple terms, no effect on health and quality of life detectable due to noise.
Lowest Observed Adverse Effect Level (LOAEL). The level above which adverse effects on health and quality of life can be detected.
Significant Observed Adverse Effect Level (SOAEL) - the level above which significant adverse effects on health and quality of life occur.

- 18.7 Where proposed developments which are categorised in the noticeable and intrusive category or higher, applicants must contact the council's Environmental Health team for pre-application advice.
- 18.8 Planning permission will normally be refused where noise meets or exceeds the level of SOAEL, however, other mitigating factors will be taken into consideration.
- 18.9 Noise which is less than SOAEL but greater than LOAEL will normally result in planning conditions to mitigate the noise.
- 18.10 Where the planning authority consider noise to be a concern under the criteria set out in table 9, the developer must undertake a noise impact assessment. The assessment should be undertaken by a qualified acoustic consultant, which should normally follow the assessment methodology and evaluation guidance in "BS 7445 1-3: 2003: Description and measurement of environmental noise", or "BS 4142: 2014: Method for rating and assessing industrial and commercial sound" as appropriate.

²⁴ DEFRA (2010) *Noise Policy Statement for England (NPSE)*

²⁵ DEFRA (2010) *Noise Policy Statement for England (NPSE)*

Noise and Vibration Assessments

- 18.11 The complexity of noise and the various assessment techniques means early contact with the borough's Environmental Health team is required to ensure the correct form of noise assessment is undertaken.
- 18.12 Applicants must undertake an environmental noise impact assessment in any area where noise is likely to cause harmful or unwarranted effects. Areas considered to be sensitive to noise include residential developments, offices, hospitals, care homes and schools.
- 18.13 Applicants must complete noise assessments where developments are proposed in areas which are already a noisy environment or will add noise to a quiet area.
- 18.14 If a noise survey is considered essential to a planning application and one has not been submitted, or has not been completed in accordance with the stipulations of council officers, this may lead to the application not being validated or planning permission being refused.
- 18.15 Planning conditions may be used to ensure the submission of noise assessments and mitigation measures or, planning conditions may be used when there is a need to limit hours of activities and other measures to ensure noise levels are acceptable.

Light Pollution

- 18.16 Artificial light can have positive impacts such as enhancing the feeling of safety or illuminating spaces in the public realm, and can be beneficial to night-time commerce. However, poorly designed lighting can affect amenity, spoil the character of areas, cause harm to wildlife and ecology, as well as waste energy. Design should limit the impact of light pollution from artificial light on local amenity, dark landscapes and nature conservation. Light pollution comprises the following.
- Glare – Intense visual sensation caused by excessive brightness when seen against a dark backdrop.
 - Light trespass – Light moving beyond the boundaries of the property where it is located.

- Sky glow – Characterised by the orange glow seen surrounding urban areas.

18.17 There are British standards with regards to road lighting (BS 5489). Lighting from a planning perspective should be sensitive to the surrounding area and the intended use. Types of lighting include the following.

- Low Pressure Sodium (LPS) - Considered to be very energy efficient but only emits a narrow spectrum of light. LPS is a good design choice in environmentally sensitive areas.
- High Pressure Sodium (HPS) - Quite energy efficient, emanating an orange-coloured light, and are commonly used for outdoor lighting such as roadways, car parks and industrial areas.
- Light Emitting Diodes (LEDs) - Metal halide are commonly used where it is desirable to use white light. They can also quickly return to full brightness after having been turned off.

18.18 LED and metal halide contain large amounts of blue light in their spectrum. Blue light brightens the night sky to a greater degree than other colours of light, however the high colouring rendering index of LED and HPS mean they provided enhanced visibility for the general public. Additionally, they can offer longer lifetimes, lower energy consumption and reduced maintenance costs.

18.19 Lighting should meet the following criteria.

- Only be on when needed and used at appropriate times.
- Only light the area that needs it and should be sited in the most appropriate locations.
- Be no brighter than necessary and be at an appropriate level to serve the task for which it intended.
- Be fully shielded (pointing downward), whenever possible. In order to minimise the sky glow effect lighting should not shine above the horizontal line of the light.
- Minimize blue light emissions.

18.20 Consideration should be given to the look of lighting equipment and the appearance in the daytime.

18.21 The need to provide lighting for security should not be compromised by the need to save energy or to avoid light pollution.

Soil

- 18.22 The National Planning Policy Framework states that the role of the planning system is to protect and enhance soils, as well as to prevent the adverse effects of pollution.
- 18.23 Topsoil and subsoil should be identified as part of the Site Waste Management Plan (SWMP) and/or the Construction Management Statement (CMS). In conjunction with ecological and environmental surveys, it should be possible to identify the topsoils and subsoils prior to excavation, and therefore subsequent appropriate reuse on or off site.
- 18.24 Incorrectly stored topsoil can lead to permanent damage and result in infertile soils being used in garden space. Topsoil should be stored for reuse in a manner appropriate to the soil type and the time of year. Construction plans should account for soil and weather differences, as well as demonstrate that plans are in place to store soil in accordance with conditions.
- 18.25 Construction plans should take action to avoid soil compaction. Soil compaction can cause irreparable damage to trees in three ways: reducing water movement through the soil, meaning less water is available for trees; reducing the amount of oxygen in the soil, eventually leading to root death; and soil compaction which can prevent roots from penetrating deeper into the ground, resulting in shallow roots and damage to infrastructure. Critical root zones of trees should be calculated, and appropriate steps taken to ensure existing trees are protected.
- 18.26 Trees help to bind soils and prevent soil erosion. Wherever possible existing trees should be protected. Where loss is unavoidable, replacement trees should be planted which will benefit soil quality.
- 18.27 Landscaping designs should consider the suitability of plants for the location, including the habitat size, tolerance to soil conditions, root spread and ease of management. Where developments include the importation of soil, soil materials should be of a standard to support vegetation. In all cases the site developer must ensure that the soil cover placed on the site is suitable for plant growth.
- 18.28 Organisations such as the Royal Horticultural Society provide information on soil types and identifying suitable plants.
- 18.29 Planning conditions may be used to ensure correct soil management practices are in place.

Part C: Major Commercial Development

19. BREEAM

19.1 Nuneaton and Bedworth Borough Council supports the use of the Building Research Establishment's Environmental Assessment Method (BREEAM). BREEAM is a sustainability assessment to measure projects, infrastructure and buildings. The assessment is conducted by a third-party assessor and examines the environmental, social and economic performance of assets. The assessment takes place over the life cycle from concept design to constructed building.

How BREEAM Works

19.2 The BREEAM categories are as follows.

- Management
- Water
- Energy
- Transport
- Health and wellbeing
- Resources
- Resilience
- Land use and ecology
- Pollution
- Materials
- Waste
- Innovation

19.3 The categories are weighted depending on the environmental section and the finished stage of the building (e.g. fully fitted out, etc.).

19.4 Some category credits are mandatory to achieve a certain rating, whilst other category credits can be interchanged. As such, where compliance is not achieved in a non-mandatory category, it can be offset by another category.

19.5 Credits can be earned by following the relevant policies set out in the Nuneaton and Bedworth Borough Plan. It is important to register with BREEAM early in the process, and to keep evidence of compliance in order to achieve the desired credit.

19.6 The benchmarks for BREEAM are detailed in Table 10.

Table 9: BREEAM benchmarks²⁶

BREEAM rating	% score
Outstanding	Achieves a rating of 85 %
Excellent	Achieves a rating of 70 %
Very Good	Achieves a rating of 55 %
Good	Achieves a rating of 45 %
Pass	Achieves a rating of 30 %

19.7 BRE regularly update the standards and guidance for BREEAM: New Construction. Developers must refer to the technical manuals on the BREEAM website for the latest requirements.

19.8 Studies have found that the estimated capital cost uplift to achieve the highest ratings are as follows.

²⁶ BREEAM (2025) *How BREEAM works*

Table 10: Increase in capital cost to achieve BREEAM benchmarks²⁷

Scheme Type	Very Good	Excellent	Outstanding
Mixed Use	0.14 %	1.58 %	4.96 %
Offices	0.17 %	0.77 %	9.83 %
Schools	0.2 %	0.7 %	5.8 %
Supermarkets	0.24 %	1.76 %	10.1 %
Warehouses	0.4 %	0.4 %	4.8 %

19.9 Table 11 highlights that there is little added cost over the base case costs to achieve a BREEAM Very Good rating.

Required Standard for New Developments

19.10 Policy BE3 requires major non-domestic construction projects to achieve at least a very good rating. In some cases the capital cost to achieve a BREEAM excellent standard is similar to the very good standard; in such cases developers are encouraged to achieve the higher standard.

19.11 Extensions to existing units which are classified as major developments are expected to adhere to BREEAM standards. A proposal which is part new construction and part refurb has two options as follows.

Option 1: Separate BREEAM New Construction and BREEAM Refurbishment and Fit-out assessments.

Option 2: Bespoke BREEAM combined New Construction and Refurbishment and Fit-out assessment.

19.12 Applicants should contact BREEAM at the earliest opportunity for guidance on the most suitable BREEAM version or scheme for maximising environmental performance.

19.13 Achieving the very good rating can be more challenging depending on the end use of the building. Where developers consider it is not technically or financially possible to meet the very good standard, a

²⁷ BREEAM (2016) *The Value of BREEAM: A review of latest thinking in the commercial building sector*

full explanation as to why must be provided, in addition to setting out what alternatives have been considered.

19.14 The council may use planning conditions to ensure a BREEAM design stage assessment is submitted prior to commencement of the development.

19.15 The council may condition any approval to ensure that the targeted BREEAM ratings are met, and that certificates are submitted to the council once the development has been completed at the post-construction stage.

Pre-Assessment

19.16 The Building Research Establishment (BRE) provide free pre-assessment tools through "BREEAM Projects", which is a one stop shop for assessing and certifying projects against BREEAM. The BREEAM Projects service should be used in all applications requiring a pre-assessment for BREEAM. The tools provided enable applicants to get an early indication of how a project might perform against BREEAM, and therefore whether they are on track to meet the very good standard required for major non-domestic commercial developments.

Part D: Sustainable Construction

20. Sustainable Materials and Management

Construction

- 20.1 The impacts of construction should be considered throughout their lifecycle, from acquisition of raw materials, demolition, potential re-use and eventual disposal.
- 20.2 Developers should use the BRE Green Guide (n.d.)²⁸ to inform the specifications of the materials used in construction. The Green Guide considers typical UK construction specifications and compares their environmental impact on a scale of A* (lowest environmental impact) to E (greatest environmental impact).
- 20.3 Developments should use resources which are procured from responsible sourcing schemes, such as the BRE BES 6001:2008 Responsible Sourcing Standard²⁹.
- 20.4 Timber should be sourced from schemes which ensure timber production and harvesting do not harm the long-term ecology of source forests. Timber should be sourced from contractors accredited by certification schemes such as the Forest Stewardship Council (FSC) or the Programme for Endorsement of Forest Certification.
- 20.5 Developers should undertake a review to identify opportunities for use of local suppliers to provide products that have originated within 50 miles of the site. Full or reserved matters application statements should include justification of the building elements strategy to be adopted in the proposed design. In the case of outline applications, a planning condition should require the statement to be provided at the reserved matters stage. This should cover the following building elements.
- Structure
 - Masonry
 - Flooring
 - Windows

²⁸ BRE (n.d.) *Green Guide to Specification*

²⁹ BRE Global Ltd. (2008) *BES 6001: Issue 1: Framework Standard for the Responsible Sourcing of Construction Products*

- Cladding

20.6 Where products are procured outside of the locality, they should have a demonstrable through-life benefit for sustainability.

Demolition Method Statement and Construction Management Plan

20.7 An appropriate demolition method statement and construction management plan should be prepared and submitted with the planning application. A planning condition may be imposed if these are not submitted. These plans should include the following.

- An overview of the project – including description of temporary and permanent work to be undertaken, as well as site plan
- A preliminary programme of work - including phasing and methodology
- Communication strategy for neighbour relations and community consultation
- Site establishment – including details of personnel to be used and their experience, site rules and PPE to be provided to personnel
- Access to the site – including HGV routing plans and measures to protect pedestrians, cyclists, assets and infrastructure that may be impacted
- Traffic management – including construction traffic and temporary signage
- Working hours
- Delivery hours
- Site layout – including loading/unloading areas, vehicle turning areas and staff parking
- Fire and emergency procedures
- Lighting - details of temporary lighting that may be required
- Security and fencing
- Health and Safety – including major H&S risks on site and H&S controls
- Scaffolding

- Main plant
- Good housekeeping
- Waste and material management - including measures to minimise deliveries, as well as measures for waste removal, waste storage and waste disposal
- Measures to prevent dust and debris being deposited on the highway; the monitoring for dust and debris on the highway; and measures to be employed should cleansing be required
- Water - measures to prevent water run-off, pollution and water pollution, as well as measures to protect water resources
- Air quality and dust management – mitigation measures as well as measures to minimise energy use and carbon emissions
- Noise and vibration – site statement to minimise noise and nuisance, setting out best practice measures and mitigation measures
- Details of temporary traffic management (this will require approval from the Warwickshire County Council Highways team)
- Mud/dust control, which must prevent highway safety risks
- Road condition surveys at both pre-construction and post-construction stages
- Delivery routing to avoid sensitive routes (schools, weight limits, etc.)

20.8 Construction activities should be planned so as to minimise the noise level and the duration of noise.

20.9 Plant and machinery should be operated at a level below 5dB(A) below the background level measured from 1 m outside the window of neighbouring residential or noise sensitive properties. There should be no perceptible noise or vibration transmitted through the structure to adjoining premises.

20.10 Consultation with the council's Environmental Health Officers is required at an early stage of development to advise on noise and air quality.

Construction Waste

20.11 Developers should aim to refurbish, repair or convert existing buildings before demolition. Existing resource should be made use

of on site, ensuring that materials which can be reused or recycled are utilised as part of the development. Waste streams should be carefully monitored to ensure waste is disposed of correctly.

20.12 The waste hierarchy is established in domestic law through the Waste (England and Wales) Regulations 2011 (as amended). The hierarchy requires that prevention is prioritised above preparation for reuse, then recycling, then other recovery, with disposal as the least preferred option. Developers are expected to demonstrate how their proposals reflect and apply the hierarchy throughout the construction process.

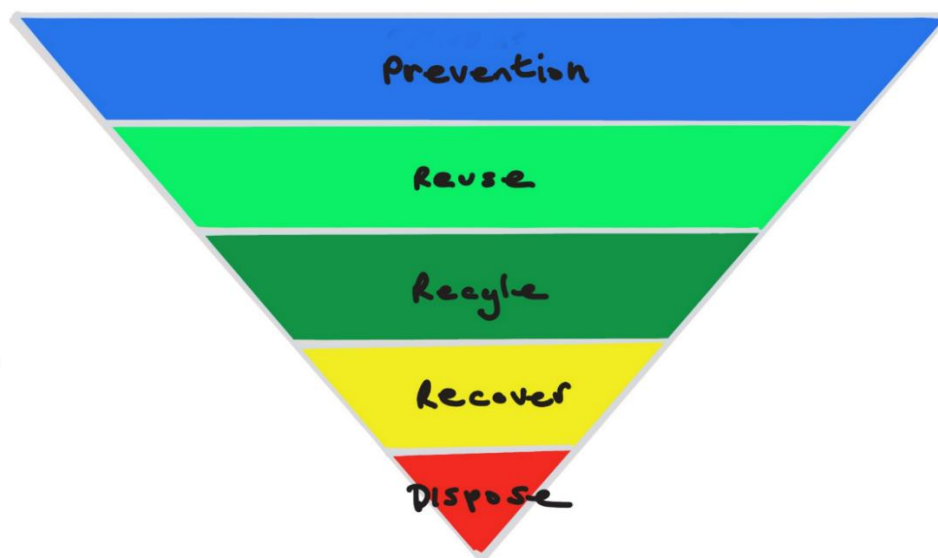

Figure 37: The waste hierarchy

20.13 Where demolition of buildings cannot be avoided, an audit of materials should be undertaken on site, and the percentage calculated of materials which can be reused or recycled.

20.14 Where aggregate is needed on-site and resources cannot be salvaged, the material should be crushed for on-site use. Measures should be taken to limit dust and noise.

20.15 Major developments should demonstrate how construction waste will be minimised and managed in a sustainable manner, including the efficient use of materials and the maximisation of reuse and recycling. This may be achieved through the preparation of a Site Waste Management Plan (SWMP) or equivalent supporting information, where appropriate.

20.16 Where justified, the council may issue planning conditions to secure details of construction waste management, including the submission and approval of a Site Waste Management Plan (or equivalent) prior to the commencement of development. Any such condition will be applied in accordance with the relevant policy tests set out in the NPPF.

20.17 The council may condition any approval to ensure that the targeted recovery rates are met, and that reports are submitted to the council once the development has been completed at the post construction stage.